

E

IMPLANTOLOGY
IMPLANTOLOGIA

OSTEOTOMES, MEDOSS LINE

OSTEOTOMI, LINEA MEDOSS

A new tip for the osteotomes of the line Medoss: the terminal portion is now conical to facilitate the insertion in the sinus cavity and has minimal/maximal diameter scale, progressive depth markings from 8 to 18 mm, by 2 mm steps.

Nuova punta degli osteotomi linea Medoss: il terminale è ora conico per agevolare l'inserimento nella cavità, avente diametro minimo e massimo; le tacche di profondità hanno scala da 8 a 18 mm, con step di 2 mm.

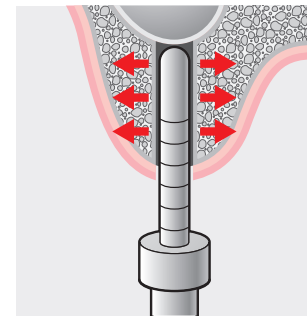

Osteotomes conceived to compact the bone before the placement of an implant and aiming at reaching greater density, which is better for initial implant support. Thanks to the new conical shape with increasing diameters the bone condensation is obtained both laterally and apically. The terminal conical portion is slightly rounded to reduce the risk of perforation of the Schneiderian membrane.

Osteotomi progettati per compattare l'osso, prima dell'inserimento dell'implanto. La compattazione avviene sia in senso laterale che verticale, grazie alla nuova forma conica e progressiva della punta. Il terminale è arrotondato per ridurre il rischio di perforare la membrana di Schneider.

SINUS CONDENSING



Straight
Retto



- 1321/1 (ø 2,0 / 2,7 mm)
 - 1321/2 (ø 2,7 / 3,2 mm)
 - 1321/3 (ø 3,2 / 3,7 mm)
 - 1321/4 (ø 3,7 / 4,2 mm)
 - 1321/5 (ø 4,2 / 5,0 mm)
- Convex
Convesso

1321/3
mm 170



Bayonet
Baionetta



- 1321/6 (ø 2,0 / 2,7 mm)
 - 1321/7 (ø 2,7 / 3,2 mm)
 - 1321/8 (ø 3,2 / 3,7 mm)
 - 1321/9 (ø 3,7 / 4,2 mm)
 - 1321/10 (ø 4,2 / 5,0 mm)
- Convex
Convesso

1321/8
mm 165



1321/KIT

Kit sinus condensing

Kit osteotomi convessi

Content / Contenuto:

- 5 osteotomes straight and
 - 5 osteotomes bayonet, convex
- 5 osteotomi retti e 5 osteotomi a baionetta, convessi



Straight
Retto

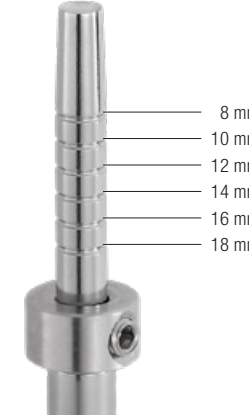

- 1322/1 (ø 2,0 / 2,7 mm)
 - 1322/2 (ø 2,7 / 3,2 mm)
 - 1322/3 (ø 3,2 / 3,7 mm)
 - 1322/4 (ø 3,7 / 4,2 mm)
 - 1322/5 (ø 4,2 / 5,0 mm)
- Concave
Concavo

1322/3
mm 175



Bayonet
Baionetta

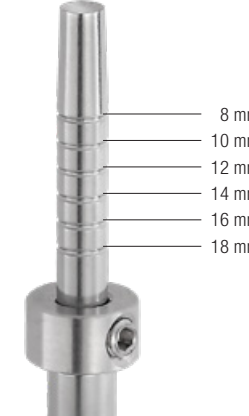

- 1322/6 (ø 2,0 / 2,7 mm)
 - 1322/7 (ø 2,7 / 3,2 mm)
 - 1322/8 (ø 3,2 / 3,7 mm)
 - 1322/9 (ø 3,7 / 4,2 mm)
 - 1322/10 (ø 4,2 / 5,0 mm)
- Concave
Concavo

1322/8
mm 165

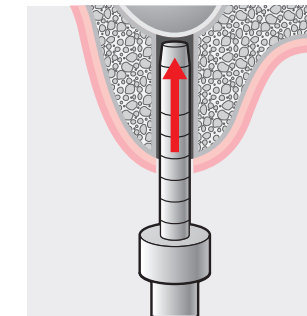

SINUS ELEVATION

Osteotomes conceived to prepare the implant site. The specific tip shape with cutting edges enables as bone grafting on the implant cavity. Concave (Cupped-ended) osteotomes are used to collect and compress bone into the apical end of the osteotomy. A far less invasive technique compared to the Sinus lift obtained by performing a "later window" approach.

Osteotomi progettati per preparare il sito implantare. La forma della punta permette di innestare l'osso della cavità e di trasportarlo alla sommità, grazie ai bordi taglienti e al terminale concavo. Tecnica meno invasiva rispetto la "lateral window".



1322/KIT

Kit sinus elevation (internal)
Kit rialzo del seno mascellare

Content / Contenuto:

- 5 osteotomes straight and
 - 5 osteotomes bayonet, concave
- 5 osteotomi retti e 5 osteotomi a baionetta, concavi

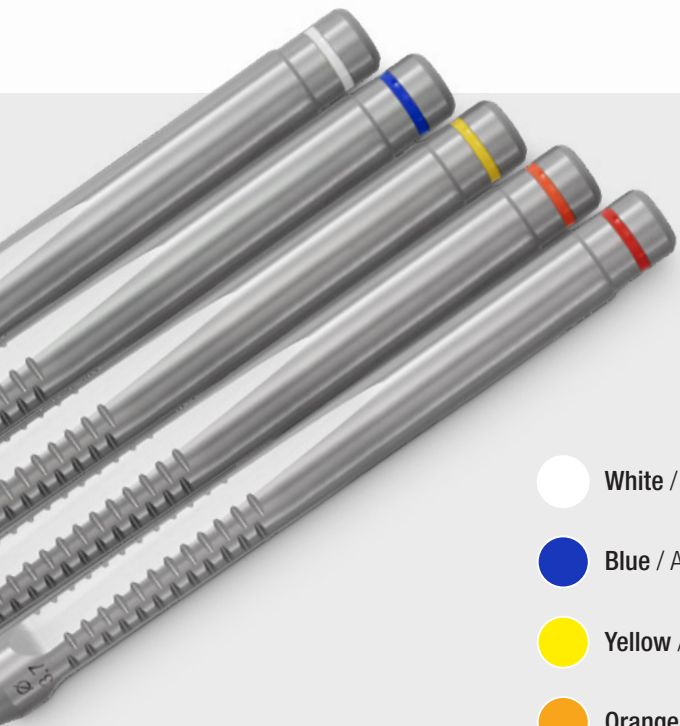

- White / Bianco** – ø 2,0 / 2,7 mm
- Blue / Azzurro** – ø 2,7 / 3,2 mm
- Yellow / Giallo** – ø 3,2 / 3,7 mm
- Orange / Arancio** – ø 3,7 / 4,2 mm
- Red / Rosso** – ø 4,2 / 5,0 mm

“ MEDESYS IN SPOT

Color codes for the new osteotomes

Codice colore per i nuovi osteotomi ”



New MEDOSS osteotomes, equipped with a practical and easy blocking device extremely compact if compared to the traditional system thus ensuring a larger visual and operative field. The supplied screwdriver operates the locking and unlocking on the osteotome stopping device.

Nuovi osteotomi MEDOSS, progettati con un semplice e pratico sistema di bloccaggio: tale sistema è estremamente compatto se confrontato con il sistema tradizionale, aumentando il campo visivo ed operativo. Il cacciavite fornito in dotazione serve a bloccare e sbloccare il sistema di stop dell'osteotomo.

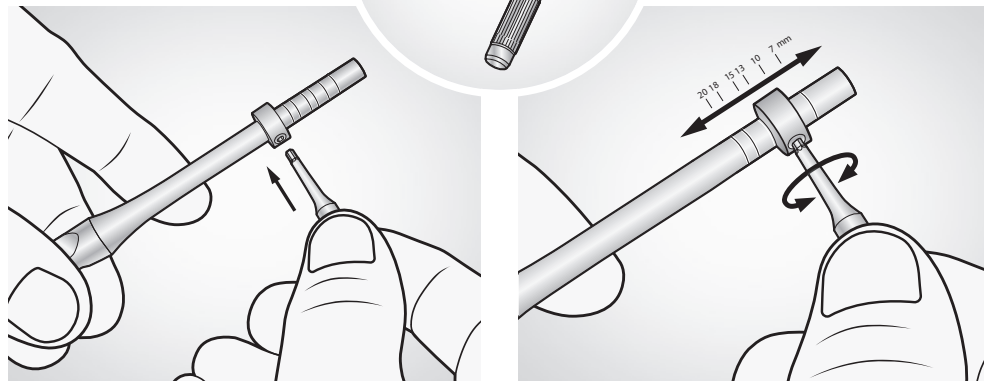
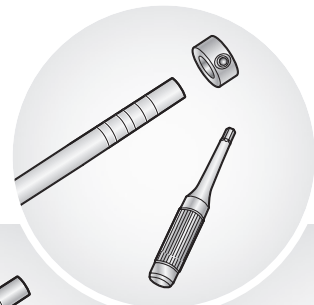

1305/KIT

Kit osteotomes
Kit osteotomi

Content / Contenuto:

1321/3	Osteotome ø 3,2 / 3,7 mm convex
1322/3	Osteotome ø 3,2 / 3,7 mm concave
1321/8	Osteotome ø 3,2 / 3,7 mm convex bayonet
1322/8	Osteotome ø 3,2 / 3,7 mm concave bayonet
1309/1	Sinus lift N. 1
1309/2	Sinus lift N. 2
1309/3	Sinus lift N. 3
661/87.HL8	Bone curette Lucas N. 87
661/88.HL8	Bone curette Lucas N. 88
980/10	Gammatrix tray Tre

Content can be changed upon request
Su richiesta il contenuto può essere cambiato

OSTEOTOMES, IMPLANT SITE DILATATORS

OSTEOTOMI, DILATATORI DEL SITO IMPLANTARE

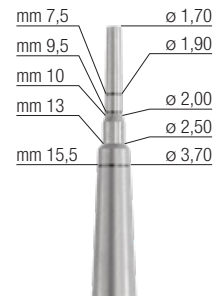

1300/1
Concave
Concavo

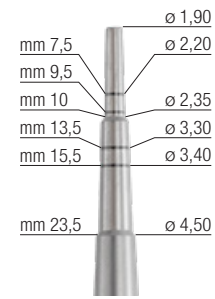

1300/2
Concave
Concavo

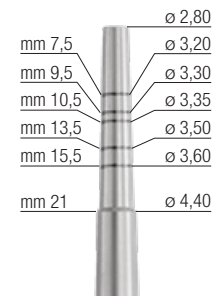

1300/3
Concave
Concavo

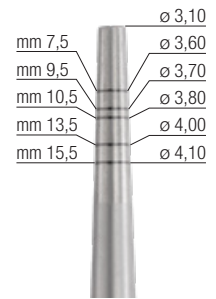

1300/4
Concave
Concavo

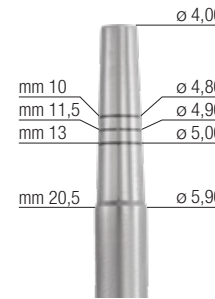

1300/5
Concave
Concavo

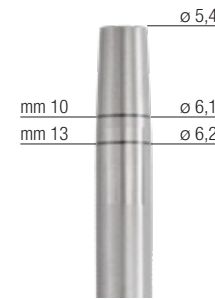

1300/6
Concave
Concavo

1300/2
mm 155

1300/KIT

Kit implant site dilators
Kit dilatori del sito implantare

Content / Contenuto:

1300/1	Osteotome N. 1
1300/2	Osteotome N. 2
1300/3	Osteotome N. 3
1300/4	Osteotome N. 4
1300/5	Osteotome N. 5
1300/6	Osteotome N. 6
980/9	Gammatrix tray Doi



MALLETS

MARTELLI



ø 26 mm
320 gr

950

Mead
Teflon spare parts (950/R)
Inserti in teflon intercambiabili (950/R)
mm 175



ø 22 mm
170 gr

951

Partsch
Hollow handle
Manico vuoto
mm 175



ø 28 mm
320 gr

952

Mead
Teflon spare parts (952/R)
Inserti in teflon intercambiabili (952/R)
mm 180



ø 20 mm
150 gr

952/20

Medesy
Teflon spare parts (952/20R)
Inserti in teflon intercambiabili (952/20R)
mm 170



ø 25 mm
190 gr

952/25

Medesy
Teflon spare parts (952/25R)
Inserti in teflon intercambiabili (952/25R)
mm 170

SINUS LIFT INSTRUMENTS

STRUMENTI PER IL RIALZO SENO MASCELLARE

1304/KIT

Kit sinus lift / Kit rialzo del seno mascellare

Content / Contenuto:

1304/901	Sinus lift N. 901	1304/904	Sinus lift N. 904
1304/902	Sinus lift N. 902	1304/905	Sinus lift N. 905
1304/903	Sinus lift N. 903	977	Tray

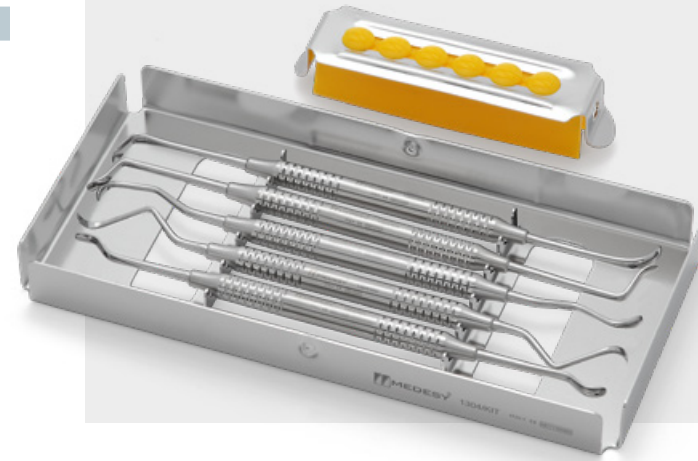

(1:1 scale / scala 1:1)

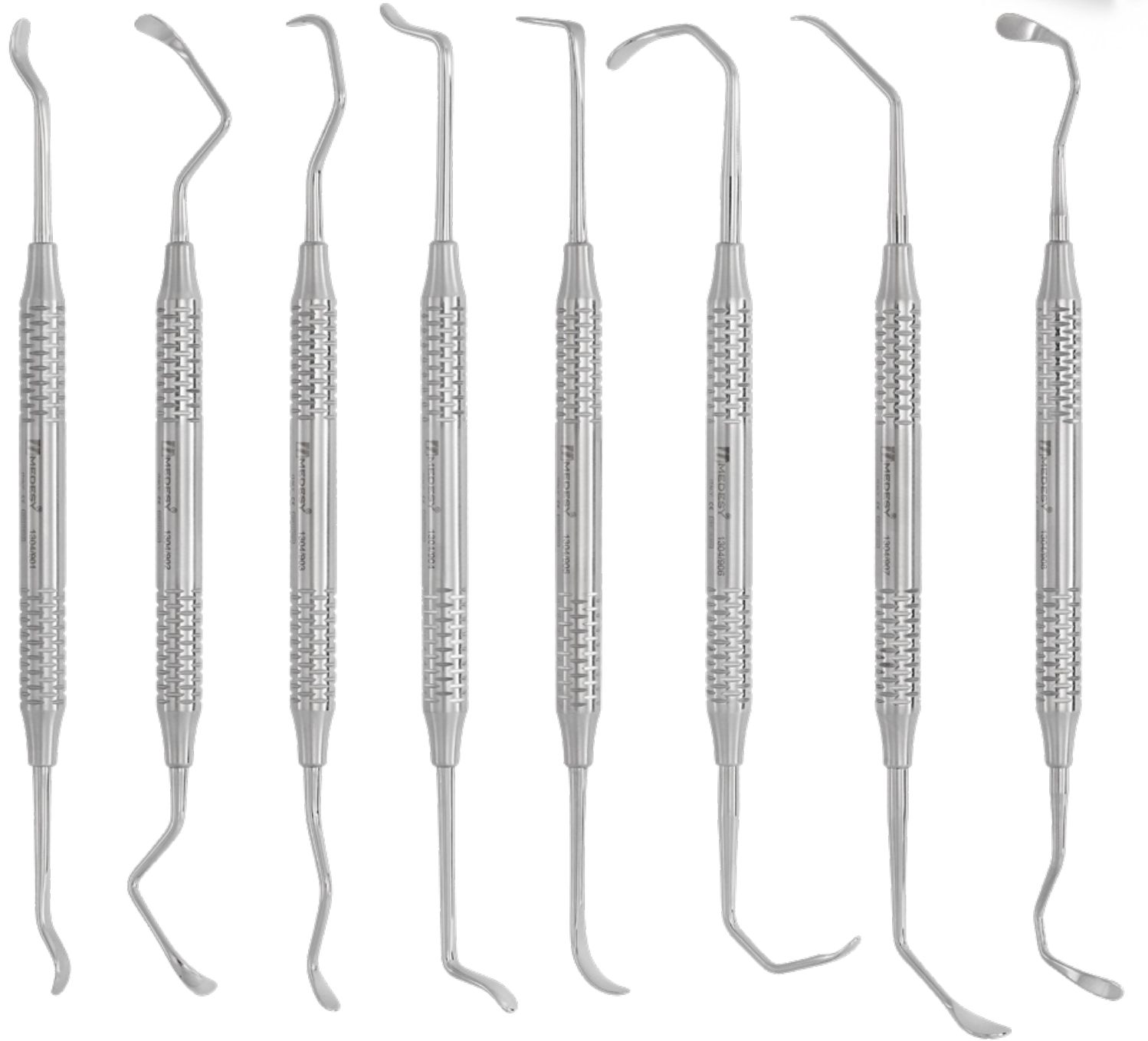

1304/901 N. 901
1304/902 N. 902
1304/903 N. 903
1304/904 N. 904
1304/905 N. 905
1304/906 Kramer-Nevis N. 906
1304/907 Kramer-Nevis N. 907
1304/908 N. 908

1309/KIT

Kit sinus lift
 Kit rialzo del seno mascellare

Content / Contenuto:

1309/2	Sinus lift N. 2
1309/3	Sinus lift N. 3
1309/5	Sinus lift N. 5
1309/7	Sinus lift N. 7
1309/9	Sinus lift N. 9
977	Tray



(1:1 scale / scala 1:1)

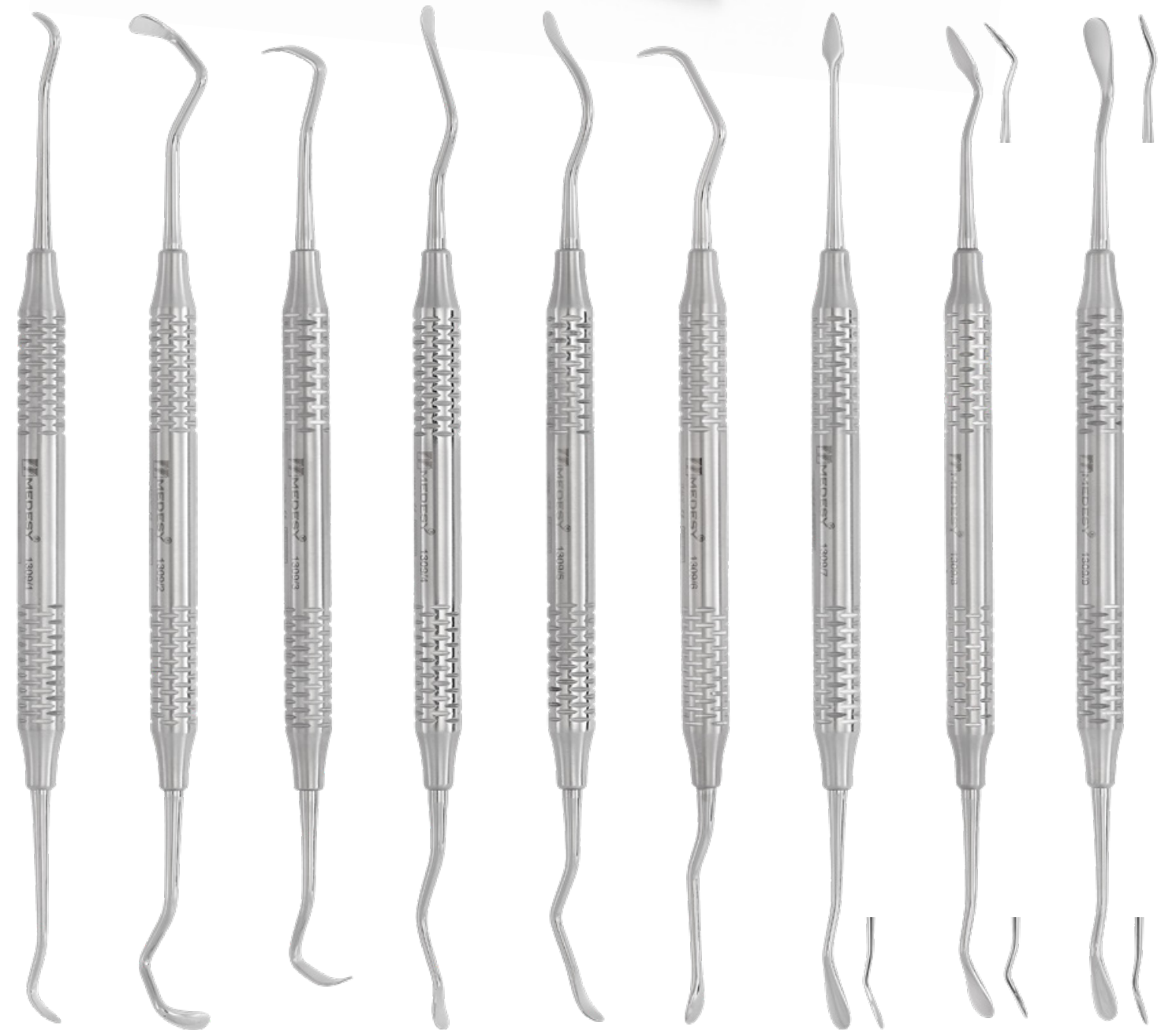

1309/1 N. 1
1309/2 N. 2
1309/3 N. 3
1309/4 N. 4
1309/5 N. 5
1309/6 N. 6
1309/7 Buser N. 7
1309/8 Buser N. 8
1309/9 Buser N. 9

NEWS



BONE CHISELS

SCALPELLI PER OSSO

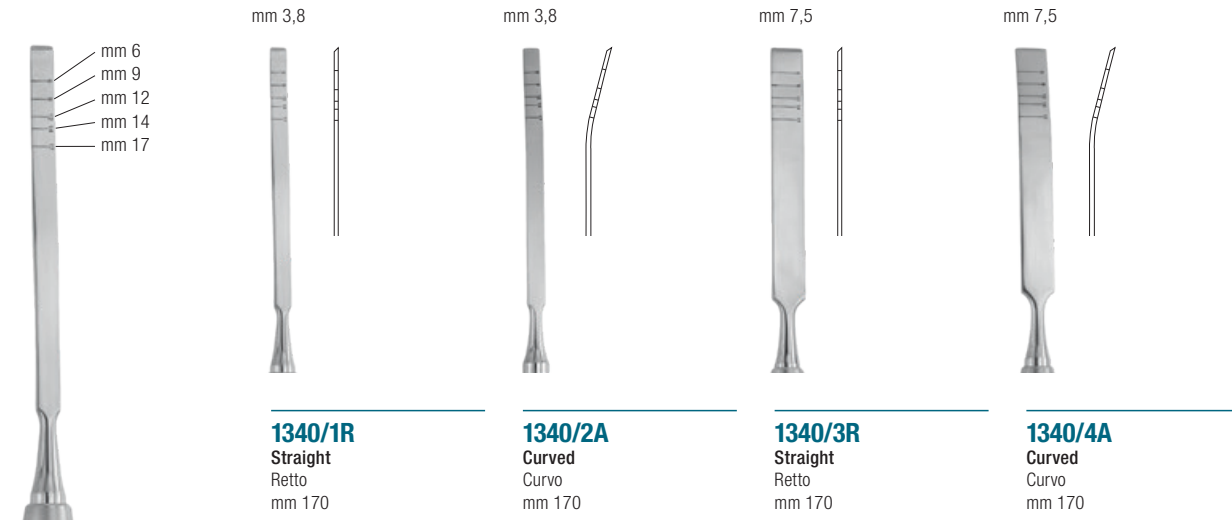

1340/1R
Straight
Retto
mm 170

1340/2A
Curved
Curvo
mm 170

1340/3R
Straight
Retto
mm 170

1340/4A
Curved
Curvo
mm 170

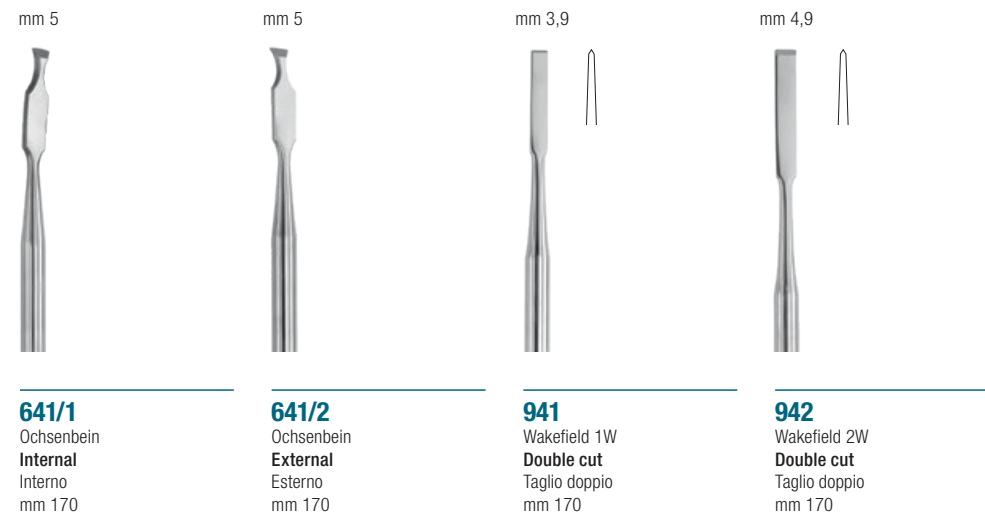

641/1
Ochsenbein
Internal
Interno
mm 170

641/2
Ochsenbein
External
Esterno
mm 170

941
Wakefield 1W
Double cut
Taglio doppio
mm 170

942
Wakefield 2W
Double cut
Taglio doppio
mm 170

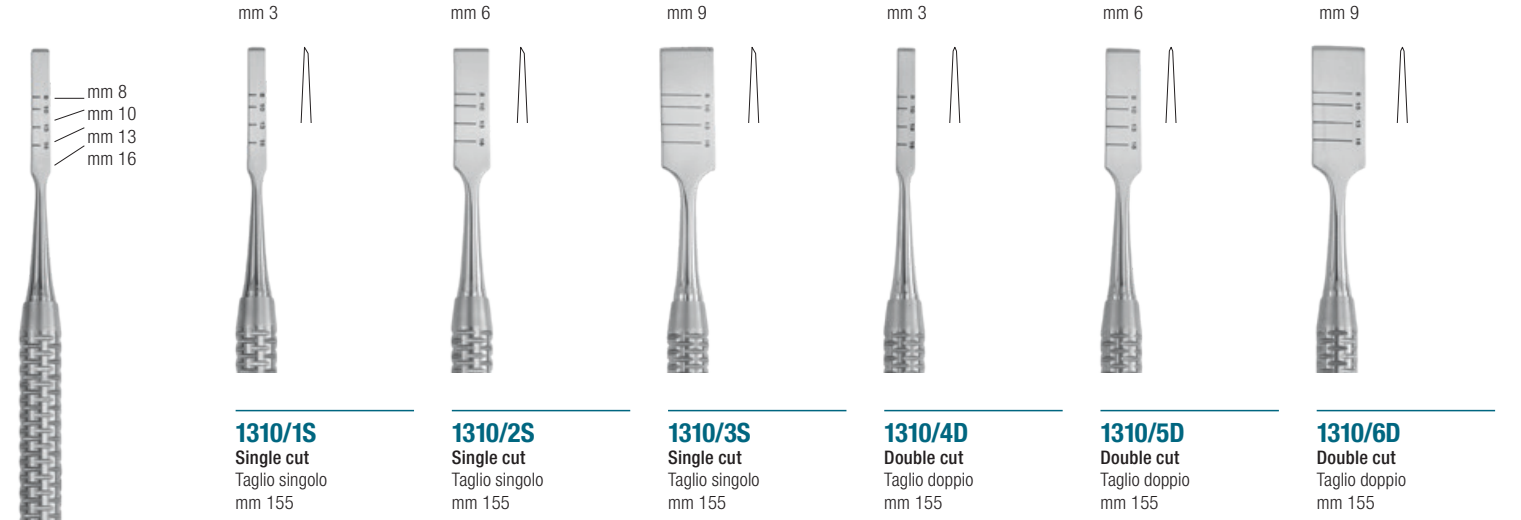

1310/1S
Single cut
Taglio singolo
mm 155

1310/2S
Single cut
Taglio singolo
mm 155

1310/3S
Single cut
Taglio singolo
mm 155

1310/4D
Double cut
Taglio doppio
mm 155

1310/5D
Double cut
Taglio doppio
mm 155

1310/6D
Double cut
Taglio doppio
mm 155

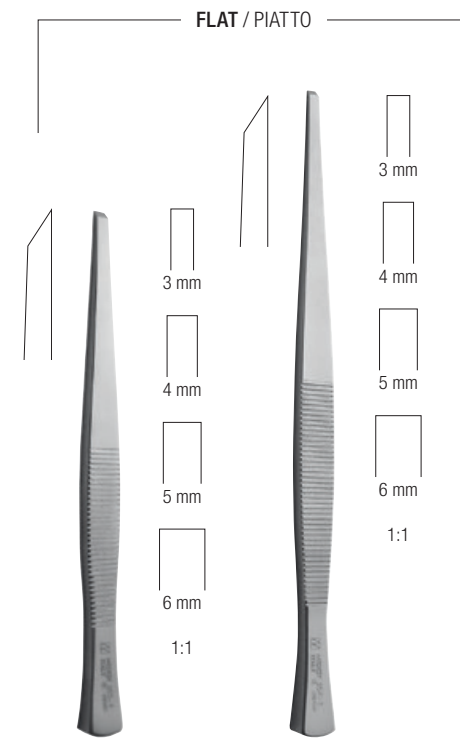

953/3 (mm 3)
953/4 (mm 4)
953/5 (mm 5)
953/6 (mm 6)
Partsch
mm 140

954/3 (mm 3)
954/4 (mm 4)
954/5 (mm 5)
954/6 (mm 6)
Partsch
mm 170

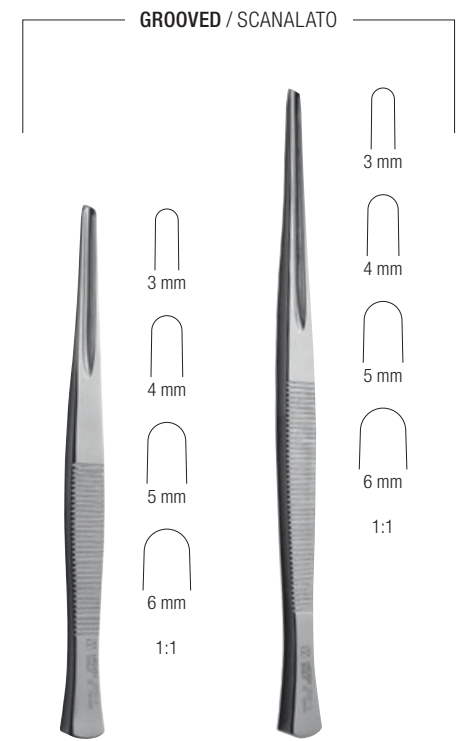

955/3 (mm 3)
955/4 (mm 4)
955/5 (mm 5)
955/6 (mm 6)
Partsch
mm 140

956/3 (mm 3)
956/4 (mm 4)
956/5 (mm 5)
956/6 (mm 6)
Partsch
mm 170

BONE SCRAPER GRATTINO PER OSSO



1325
Straight
Retto
mm155

1325/LR
Spare part for 1325
Ricambio per 1325

Bone scraper essential instrument for collecting autogenous bone used for bone-regeneration. Its unique shape and sharp blade empower the collection of the cortical bone in the device's chamber. The graft is harvested with coagulated blood for easy and safe immediate implantation.

Grattino per osso, indispensabile strumento per utilizzare osso autologo. Grazie alla sua struttura permette di rimuovere l'osso per mezzo della lama affilata e raccoglierlo nell'apposito contenitore. L'utilizzo di osso autologo sarà poi immediato.



1325/A
Curved
Curvo
mm150

1325/LRA
Spare part for 1325/A
Ricambio per 1325/A



1317/5.HL8
Medesy BSP1
Bone scoop / plugger
Cucchiaio e compattatore

BONE MILL AND BONE CRUSHER PINZA MACINA OSSO E TRITURATORE

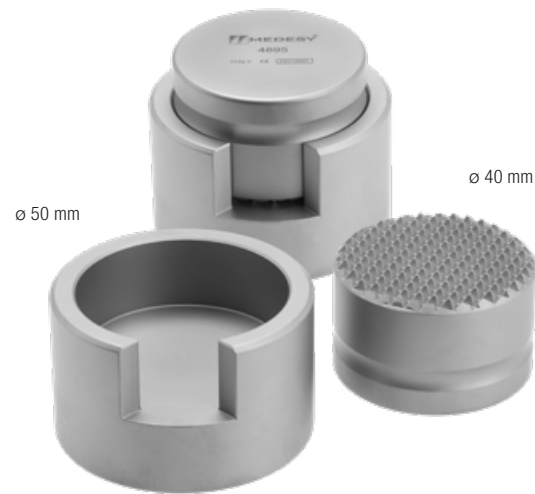

4895
Bone crusher for large bone pieces, inox
Trituratore per osso per porzioni grosse, inox
520 gr

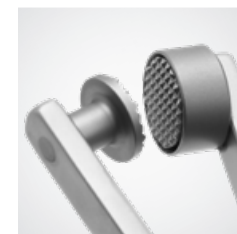

Milling part in pure Titanium
(spare parts under request)
Macinatore in puro Titanio
(parti di ricambio a richiesta)



4892
Bone mill forceps
Pinza macina osso
mm 175

BONE INJECTORS AND COLLECTORS INIETTORI E CONTENITORI PER OSSO

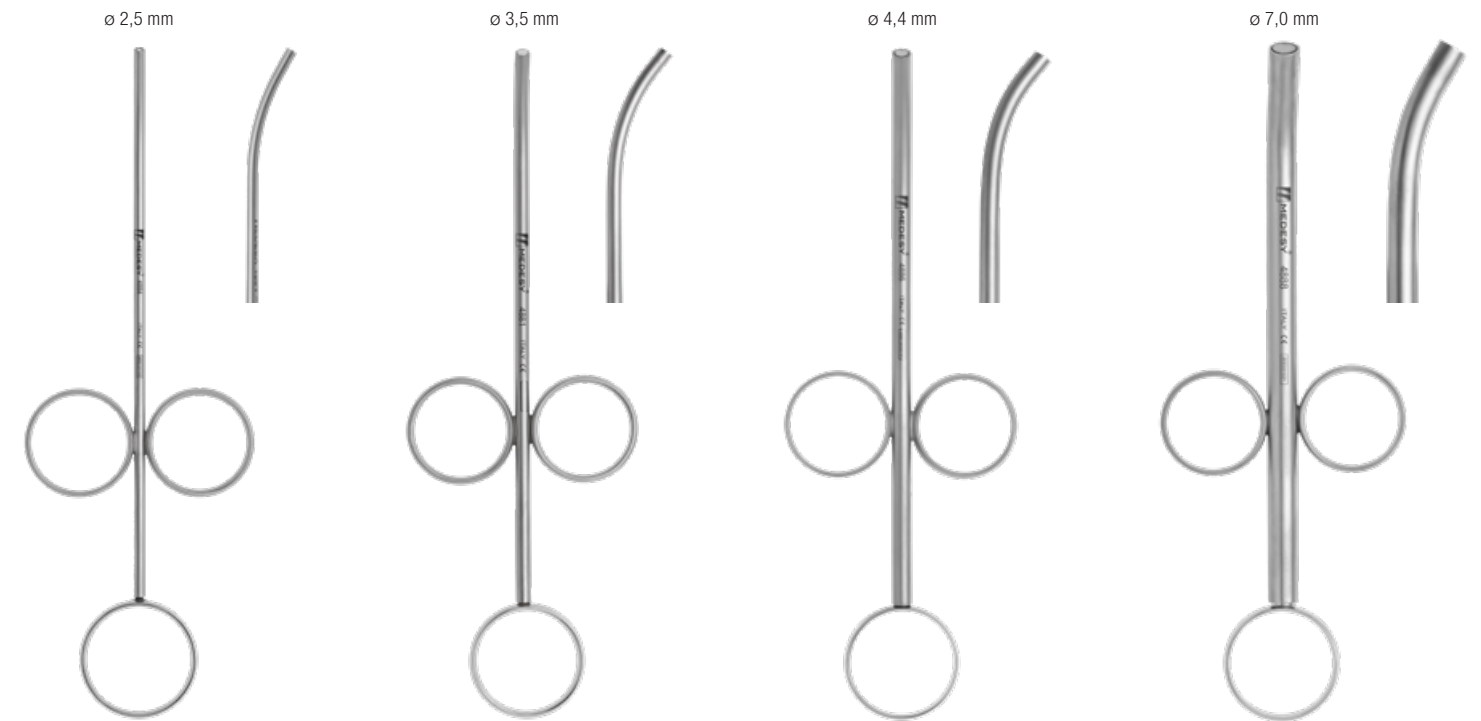

4884
mm 160

4881
mm 160

4886
mm 160

4888
mm 160



4885/BC
Medesy Bone Collector
Cucchiaio per osso Medesy
mm 160



675/MBC
Mixing and Bone Collector spatula
Spatola per mescolare e raccogliere osso
mm 180



4861/MOD
Bone injector
Iniettori d'osso
mm 155



Ti **1162**
Mini tray titanium
Vassoio mini titanio



4854
Well in stainless steel
Mortaino in acciaio

BONE PLUGGERS COMPATTATORI PER OSSO

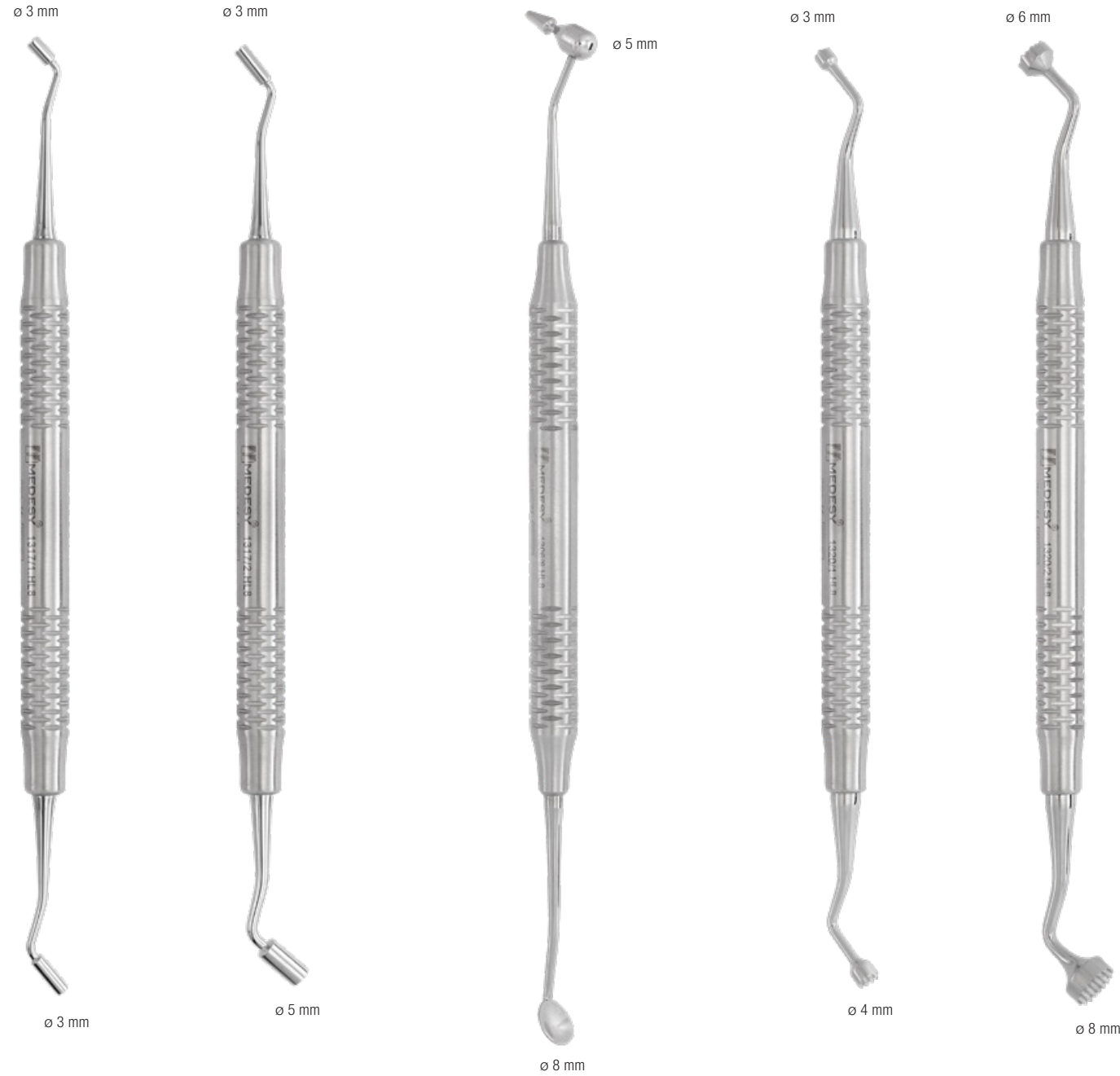

1317/1.HL8

Medesy BP1
Bone pluggers
Compattatore per osso

1317/2.HL8

Medesy BP2
Bone pluggers
Compattatore per osso

1306/8.HL8

Utility bone plugger/collector
Strumento per compattare/
raccogliere osso

1320/1.HL8

Bone compactor
Compattatore d'osso

1320/2.HL8

Bone compactor
Compattatore d'osso

TWEEZERS FOR PINS AND ABUTMENTS PINZETTE PER PINS E ABUTMENTS



1144/Ti

Pure titanium – Straight
Puro titanio – Retta
mm 155

1145/Ti

Pure titanium – Curved
Puro titanio – Curva
mm 150

MEMBRANE INSTRUMENTS STRUMENTI PER MEMBRANE



1112

Straight
Retta
mm 120

1113

Curved
Curva
mm 120

(1:1 scale / scala 1:1)



1316/1.HL8

Membrane placer
Strumento per posizionare membrane

BONE GRAFT HOLDING PLIERS
PINZE TRATTIENI OSSO

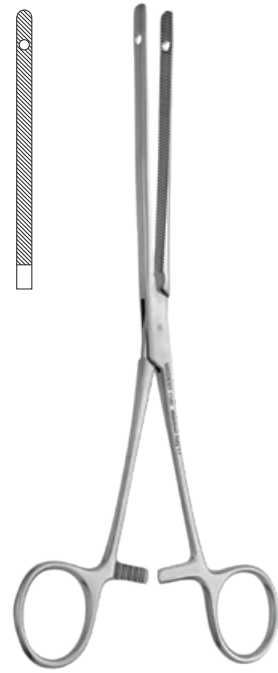

1540
Arnhold
Straight
Retta
mm 220



1541
Arnhold
Curved
Curva
mm 220



1542
Arnhold
Curved
Curva
mm 200



For placing screws on bone blocks
Per fissare viti in blocchetti d'osso

CRANIO-FACIAL FORCEPS
PINZE CRANIO-FACCIALI



1545
Rowe
Left
Sinistro
mm 225



1546
Rowe
Right
Destro
mm 225

TITANIUM INSTRUMENTS
STRUMENTI IN TITANIO

(1:1 scale / scala 1:1)



1140
Micro tweezer titanium – Straight
Micro pinzetta titanium – Retta
mm 150

(1:1 scale / scala 1:1)



1141
Micro tweezer titanium – Curved
Micro pinzetta titanium – Curva
mm 150

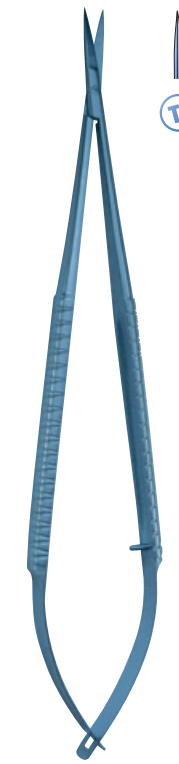

1970
Micro scissors titanium – Straight
Micro forbici titanium – Retta
mm 180

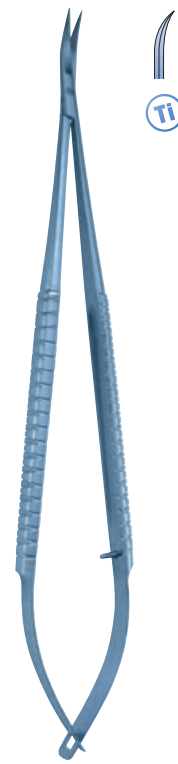

1971
Micro scissors titanium – Curved
Micro forbici titanium – Curva
mm 180



2010
Micro needleholder titanium – Straight
Micro porta-ago titanium – Retta
mm 180



2012
Micro needleholder titanium – Curved
Micro porta-ago titanium – Curva
mm 180

(1:1 scale / scala 1:1)

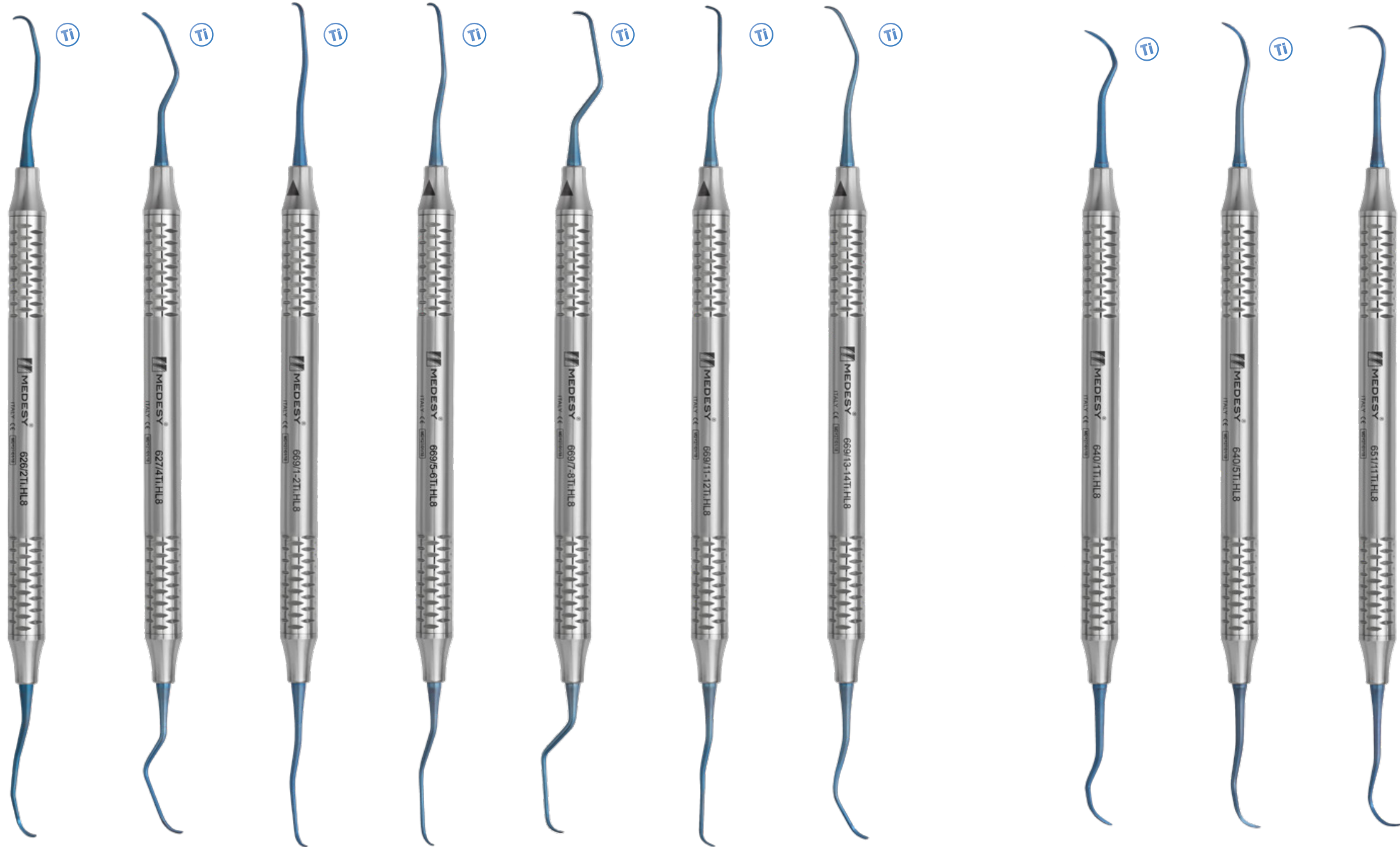

626/2Ti.HL8
Langer 1/2
Titanium
Titanio

627/4Ti.HL8
Columbia 4R/4L
Titanium
Titanio

669/1-2Ti.HL8
Gracey Short type
Titanium
Titanio

669/5-6Ti.HL8
Gracey Short type
Titanium
Titanio

669/7-8Ti.HL8
Gracey Short type
Titanium
Titanio

669/11-12Ti.HL8
Gracey Short type
Titanium
Titanio

669/13-14Ti.HL8
Gracey Short type
Titanium
Titanio

640/1Ti.HL8
Scaler 204 S
Titanium
Titanio

640/5Ti.HL8
Scaler 204 SD
Titanium
Titanio

651/11Ti.HL8
Hygienist H6/H7
Titanium
Titanio

KIT PERIMPLANTITE

The bacterial aggression observed on the neck portion of the implants is similar to the bacterial aggression observable at the muco-gingival junction of the tooth. The stainless steel instruments may contaminate the titanium made implants while plastic instruments do not fully remove the failing tissues around the implant. Hence the need of using instruments made of titanium, the unique solution for a real efficient and fully safe handling on and close to the implants sites. Blue colour for a simple and fast identification of titanium tips, from standard gray of stainless steel.

L'aggressione batterica osservata nel collo degli impianti è simile a quella presente a livello della giunzione muco gengivale del dente. Gli strumenti in acciaio possono contaminare il titanio degli impianti, mentre quelli in plastica non sono in grado di rimuovere in modo efficiente la parte in oggetto. Da qui la necessità di usare strumenti in titanio, la soluzione sicuramente più adeguata per una gestione del problema efficiente ed in piena sicurezza in prossimità degli impianti. Il colore blu delle punte, serve per identificare in modo semplice e sicuro il titanio impiegato, rispetto al tradizionale acciaio.



1671/3

Perimplantite Kit
Kit Perimplantite

Content / Contenuto:

548/4 PT	Probe CP15
627/4Ti.HL8	Curette Columbia 4R/4L Titanium
651/11Ti.HL8	Scaler H6-H7 Titanium
669/5-6Ti.HL8	Gracey short type Titanium
669/7-8Ti.HL8	Gracey short type Titanium
669/11-12Ti.HL8	Gracey short type Titanium
669/13-14Ti.HL8	Gracey short type Titanium
980/9	Gammafix tray Doi



4578
145 mm



4580
Medesy
155 mm



4987/1R (Straight / Retto)
4987/2A (Curved / Curvo)
Castroviejo
mm 85



4995/1R (Straight / Retto)
4995/2A (Curved / Curvo)
Castroviejo
mm 170

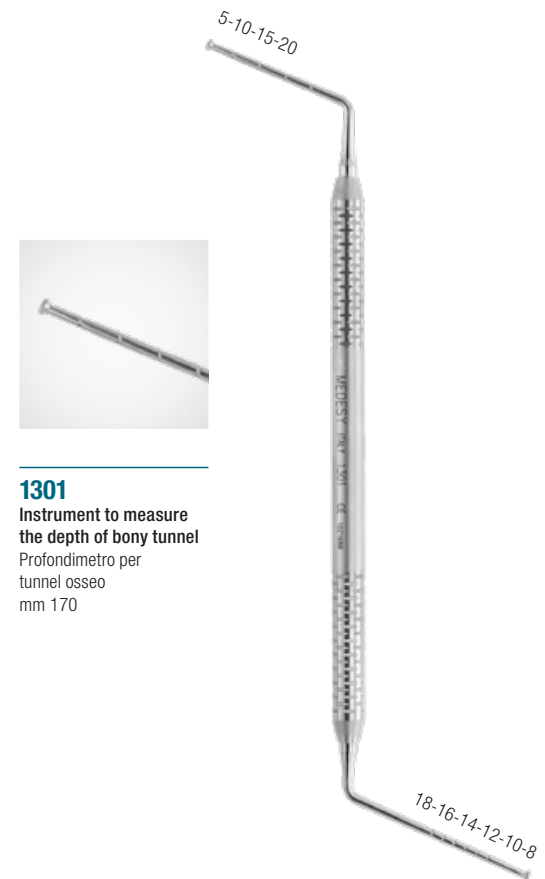

1301
Instrument to measure
the depth of bony tunnel
Profondimetro per
tunnel osseo
mm 170

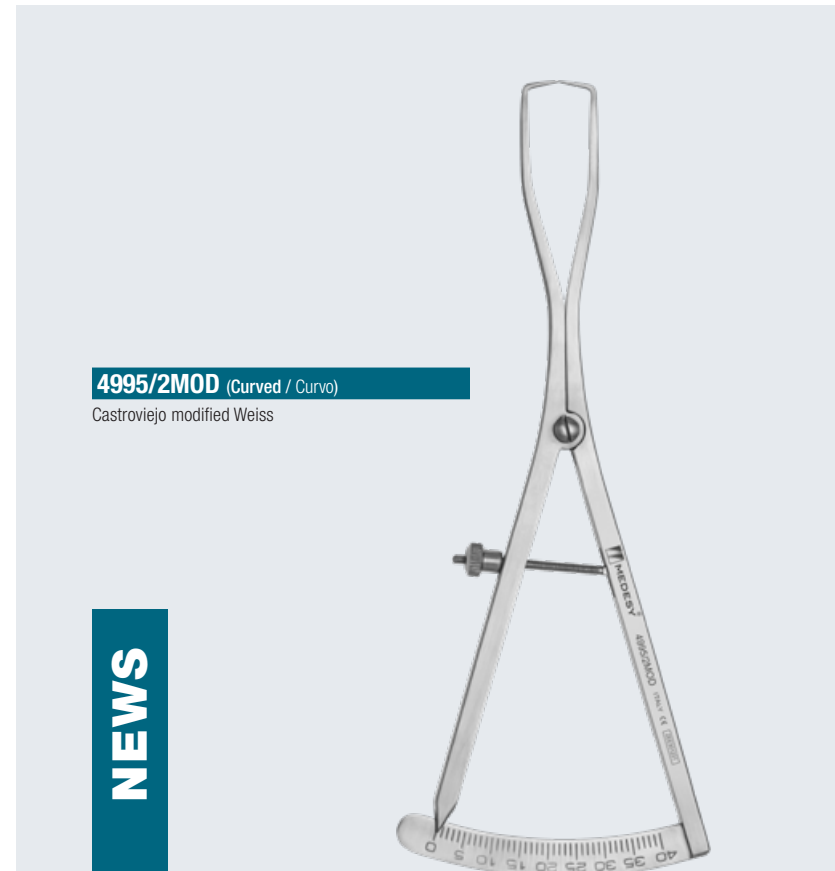

4995/2MOD (Curved / Curvo)
Castroviejo modified Weiss

NEWS

1350/KIT

Kit bone splitting
Kit per osso

Content / Contenuto:	
1304/901	Sinus lift n.901
1304/902	Sinus lift n.902
1304/905	Sinus lift n.905
1310/1S	Chisel 3 mm
1310/2S	Chisel 6 mm
1310/3S	Chisel 9 mm
3809	Bone rongeur Micro Friedman
941	Chisel Wakefield 1W
942	Chisel Wakefield 2W
952/25	Hammer Medesy
981/19	Gammatrix tray Quatri

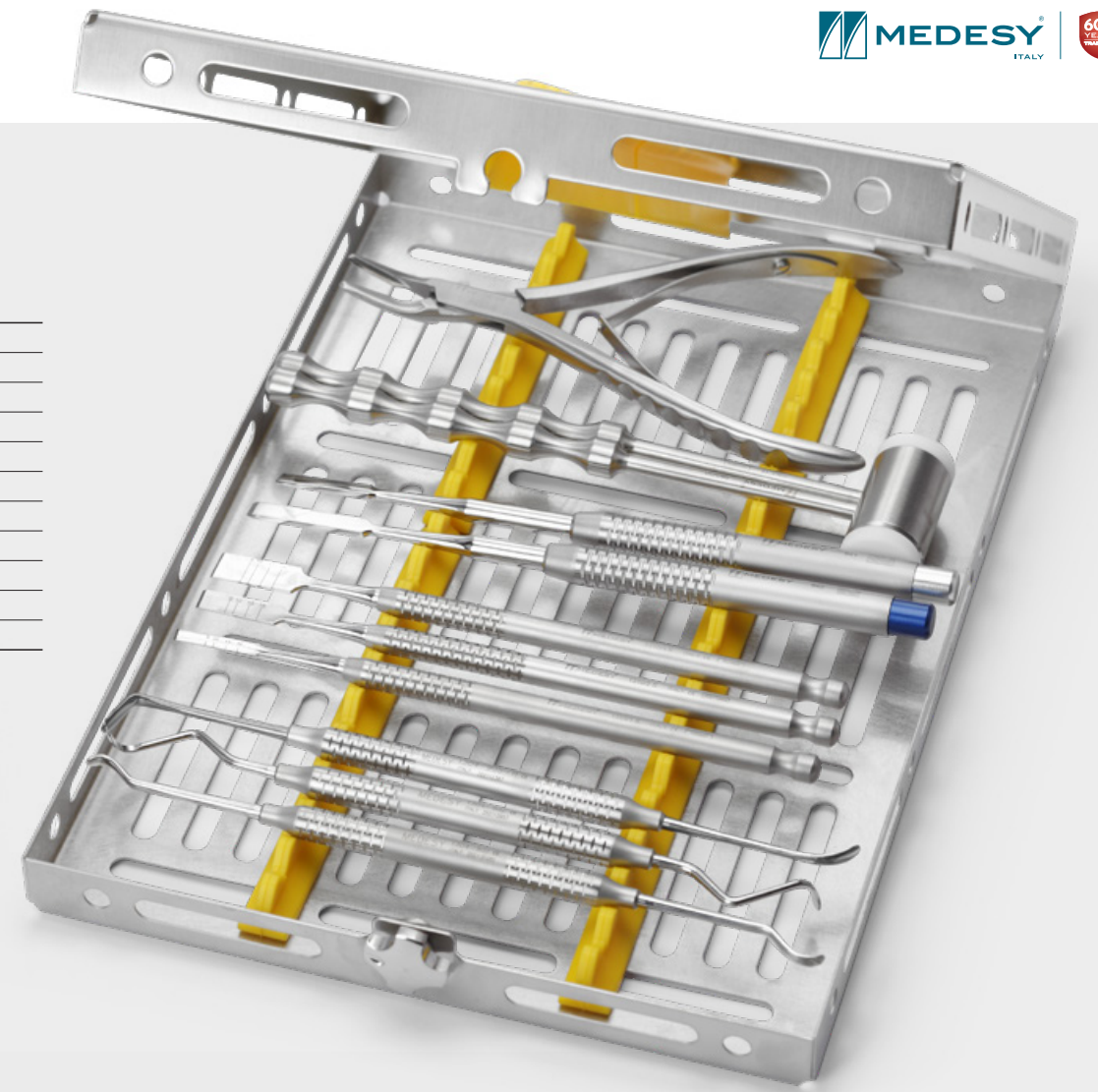

1955/KIT

Kit bone split and sinus lift
Kit per osso e rialzo del seno mascellare

Content / Contenuto:	
1304/902	Sinus lift n.902
1304/905	Sinus lift n.905
1309/7	Sinus lift n.7
1310/5D	Chisel 6 mm
1310/6D	Chisel 9 mm
1340/1R	Chisel 1R
1340/2A	Chisel 2A
1340/3R	Chisel 3R
1340/4A	Chisel 4A
980/10	Gammatrix tray Tre

1673/5

Kit osteotomes & sinus elevation

Kit osteotomi e rialzo del seno mascellare

Content / Contenuto:

1322/1	Osteotome concave ø 2,7 mm
1322/2	Osteotome concave ø 3,2 mm
1322/3	Osteotome concave ø 3,7 mm
1322/4	Osteotome concave ø 4,2 mm
1322/5	Osteotome concave ø 5,0 mm
1322/6	Osteotome concave ø 2,7 mm bayonet
1322/7	Osteotome concave ø 3,2 mm bayonet
1322/8	Osteotome concave ø 3,7 mm bayonet
1322/9	Osteotome concave ø 4,2 mm bayonet
1322/10	Osteotome concave ø 5,0 mm bayonet
4881	Bone injector ø 4,4 mm
4886	Bone injector ø 3,5 mm
952/25	Hammer Medesy ø 25 mm
981/19	Gammafix tray Quatri



1673/7

Kit sinus advanced

Content / Contenuto:

1309/1	Sinus lift n.1
1309/2	Sinus lift n.2
1309/7	Sinus lift n.7
1321/2	Osteotome convex ø 3,2 mm
1321/3	Osteotome convex ø 3,7 mm
1321/7	Osteotome convex ø 3,2 mm bayonet
1321/8	Osteotome convex ø 3,7 mm bayonet
1322/2	Osteotome concave ø 3,2 mm
1322/3	Osteotome concave ø 3,7 mm
1322/7	Osteotome concave ø 3,2 mm bayonet
1322/8	Osteotome concave ø 3,7 mm bayonet
661/85.HL8	Bone curette Lucas n.85
661/86.HL8	Bone curette Lucas n.86
661/87.HL8	Bone curette Lucas n.87
952/25	Hammer Medesy ø 25 mm
981/19	Gammafix tray Quatr