



G

**LABORATORY
LABORATORIO**

WAX AND MODELLING INSTRUMENTS

STRUMENTI PER MODELLARE



Stainless steel handle ø 6 mm
Manico inox con diametro ø 6 mm

583/KIT

Content / Contenuto:

| | |
|--------------|------------------|
| 583/1 | P.K. Thomas N. 1 |
| 583/2 | P.K. Thomas N. 2 |
| 583/3 | P.K. Thomas N. 3 |
| 583/4 | P.K. Thomas N. 4 |
| 583/5 | P.K. Thomas N. 5 |
| 977 | Gammafix tray |

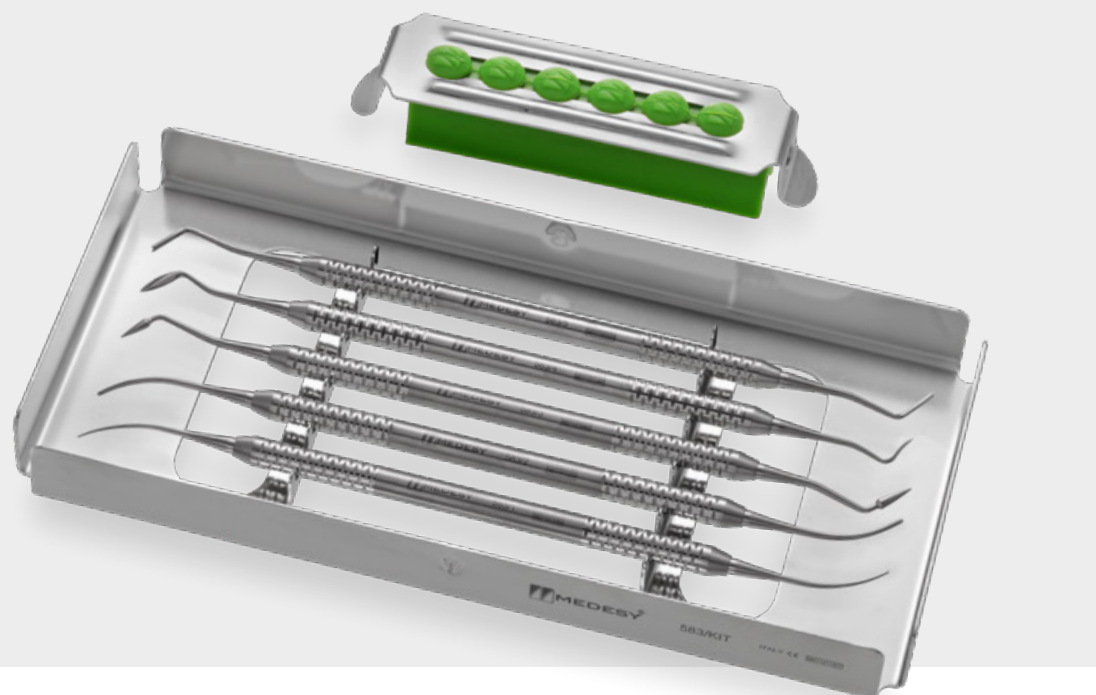

Aluminium handle anodized in 5 colors ø 8 mm
Manico in alluminio anodizzato in 5 colori diametro ø 8 mm

(1:1 scale / scala 1:1)



583/1.AL

P.K. Thomas N. 1

Aluminium handle yellow
Manico in alluminio giallo

583/2.AL

P.K. Thomas N. 2

Aluminium handle green
Manico in alluminio verde

583/3.AL

P.K. Thomas N. 3

Aluminium handle blue
Manico in alluminio blu

583/4.AL

P.K. Thomas N. 4

Aluminium handle red
Manico in alluminio rosso

583/5.AL

P.K. Thomas N. 5

Aluminium handle silver
Manico in alluminio argento

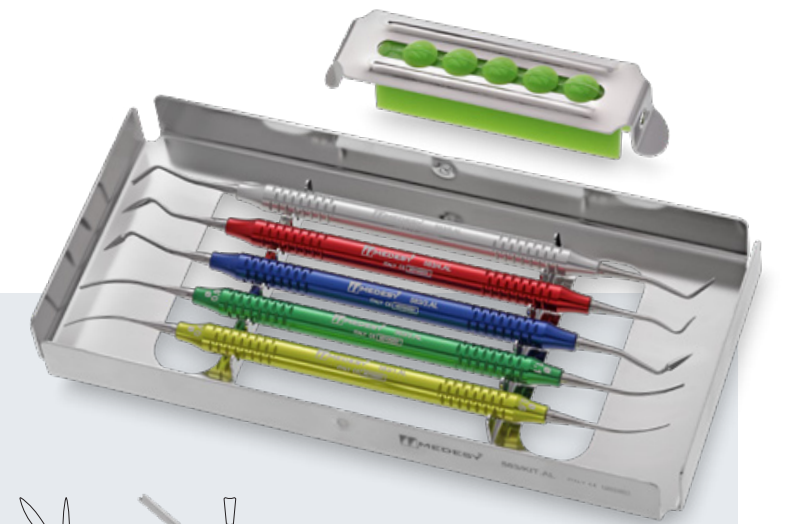

583/KIT.AL

Content / Contenuto:

| | |
|-----------------|------------------|
| 583/1.AL | P.K. Thomas N. 1 |
| 583/2.AL | P.K. Thomas N. 2 |
| 583/3.AL | P.K. Thomas N. 3 |
| 583/4.AL | P.K. Thomas N. 4 |
| 583/5.AL | P.K. Thomas N. 5 |
| 977 | Gammafix tray |

NEWS

WAX KNIVES COLTELLI PER CERA

(1:1 scale / scala 1:1)



201
Fahnenstock
mm 130

202
Fahnenstock
mm 180

205
Lessmann
mm 130

206
Lessmann
mm 180

214
Gritmann
mm 170

WAX AND MODELING INSTRUMENTS STRUMENTI PER MODELLARE

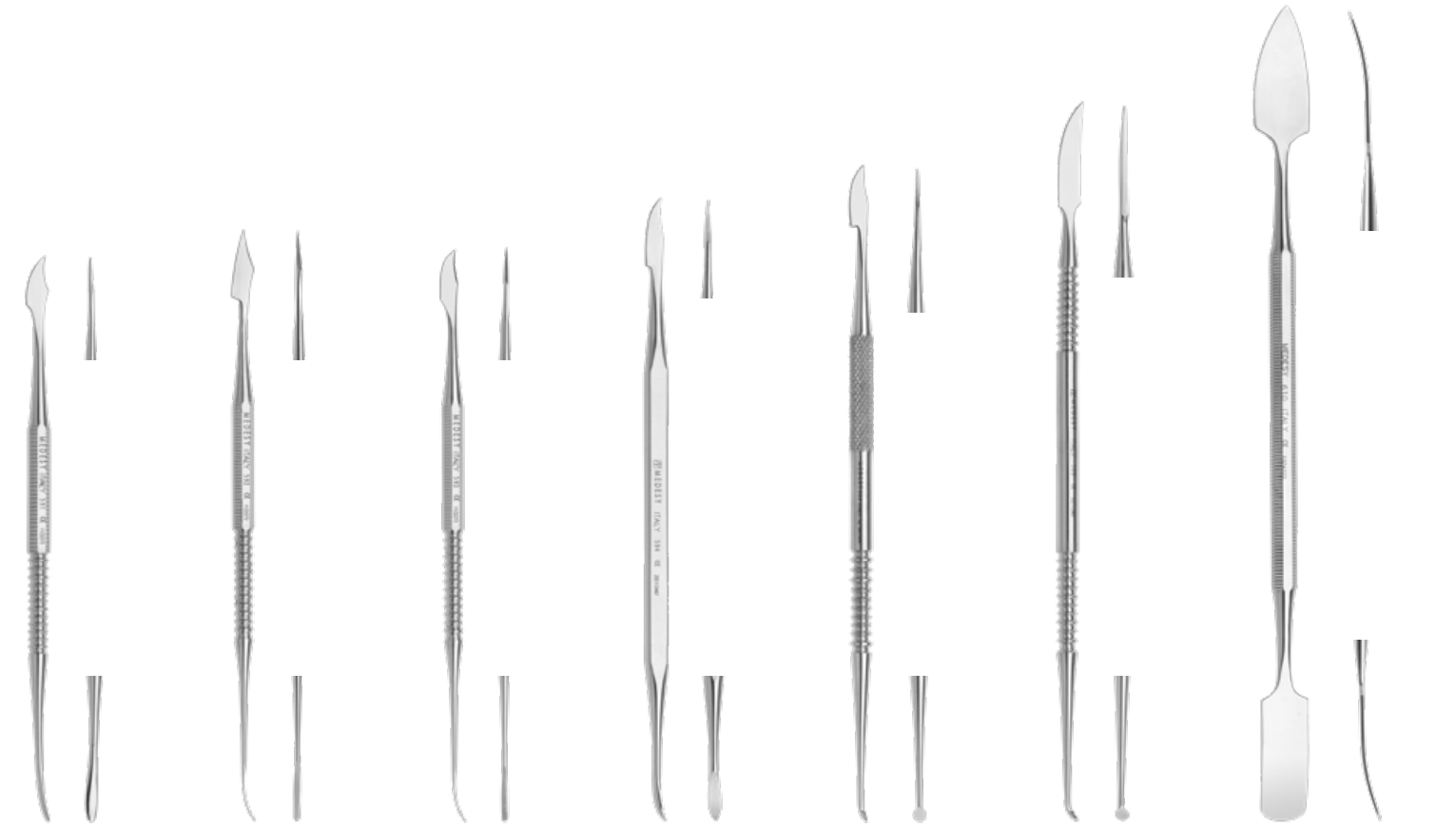

591
Zahle
mm 120

592
Zahle
mm 130

593
Zahle
mm 125

594
Hyllin
mm 135

596
Hyllin
mm 145

588
Le Cron
mm 165

610
Gritman
mm 180



599/1

599/2

599/3

599/4

599/5

599/KIT

Kit of wax and modeling instruments with insulated and autoclavable handle, on 977 tray
Kit di strumenti per modellare con manico isolante ed autoclavabile, su vassoio 977

Content / Contenuto:

- 599/1** Wax and modeling instruments N. 1
- 599/2** Wax and modeling instruments N. 2
- 599/3** Wax and modeling instruments N. 3
- 599/4** Wax and modeling instruments N. 4
- 599/5** Wax and modeling instruments N. 5



CERAMIC SCULPTING INSTRUMENTS

STRUMENTI PER CERAMICA

Special set of ceramic sculpting instruments light weight handles and stainless steel tips, different shape: gingival blade, incisal blade and knife blade.

Manici leggeri e punte di forme diverse in acciaio inox, lama gengivale, lama incisale, lama coltello.

(1:1 scale / scala 1:1)



575/1
Greenstein N. 1

575/2
Greenstein N. 2

575/3
Greenstein N. 3



577/1 **577/2** **577/3**

Superflexible tips, thickness 0,1 mm
Puntali superflessibili, spessore 0,1 mm

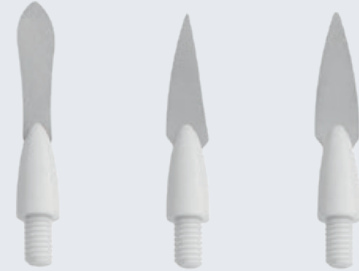

577/4 **577/5** **577/6**

Flexible tips, thickness 0,2 mm
Puntali flessibili, spessore 0,2 mm

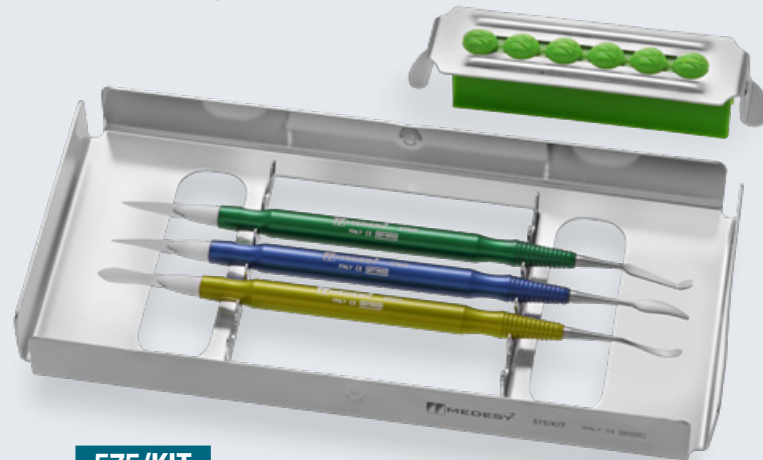

575/KIT

Content / Contenuto:

- 575/1** Greenstein N. 1
- 575/2** Greenstein N. 2
- 575/3** Greenstein N. 3
- 577/1** Superflexible tips N. 1
- 577/2** Superflexible tips N. 2
- 577/3** Superflexible tips N. 3
- 977** Tray

NEWS

(1:1 scale / scala 1:1)

CERAMIC SCULPTING SPATULA BY DR. COMELLA

SPATOLA PER CERAMICA BY DR. COMELLA

NEWS

WATCH THE VIDEO
ON YouTube
MEDESYS CHANNEL!

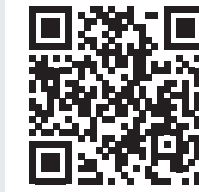

Discover how it was born!
Scopri com'è nata!



Discover the spatula
Scopri la spatola



(1:1 scale / scala 1:1)

572

Spatula Dr. Comella
Spatola Dr. Comella

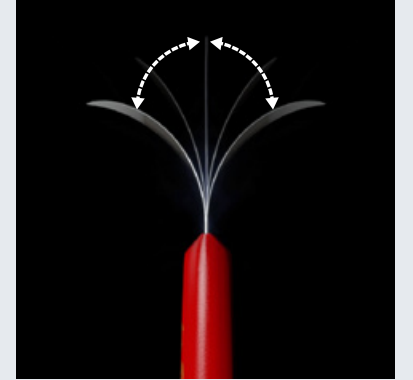

Flexible blade
Lama flessibile



Optimal handling
Maneggevolezza ottimale

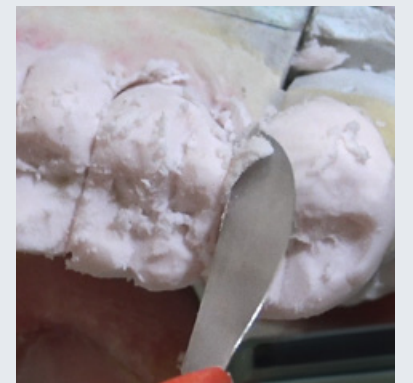

Sharp to refine details
Affilata per rifinire dettagli

CEMENT SPATULAS SPATOLE PER CEMENTI

(1:1 scale / scala 1:1)



676/24

4,0



3,5

675/0

5,5



5,5

675/1

6,5



6,5

675/2

7,5



7,5

675/3

9,5



6,5

675/4

NEWS

PLASTER AND ALGINATE SPATULAS SPATOLE PER GESSO ED ALGINATO



208
Spatula 8 x
Spatola 8 x
mm 230



209
mm 215



210
mm 215



211
Curved, rigid
Curva, rigida
mm 200



213/2
Rigida
Rigida
mm 180



115
Flexible, elastomers
Flessibile, elastomeri
mm 190

PLASTER SHEARS AND SAWS CESOIE PER GESSO E SEGHETTI



4559
Insulated handle
Manici in plastica
mm 210

4990



4990/3

Package 12 pcs
Sacchetti da 12 pezzi
mm 0,12 x 5

4990/2

Package 12 pcs
Sacchetti da 12 pezzi
mm 0,25 x 5

4990/1

Package 12 pcs
Sacchetti da 12 pezzi
mm 0,25 x 3

NEWS

ARTICULATOR ARTICOLATORE

Medesy new articulator non-Arcon average value, solidly manufactured in cast aluminium, about 580gr in weight. Projected and realized to ensure the largest visual field on the lingual surfaces as well as maintaining complete stability of the upper frame also at full open position: coiled springs facilitate the return to starting aligned position. Additional features guarantee an exact simulation of the condylar path with a high fitting accuracy, giving the necessary occlusion function throughout the full range of mandibular movements.

Technical details:

- ▷ Stable 60° operation for technician comfort.
- ▷ Ideal for class III patients.
- ▷ Compatible with any pressure polymerizers.
- ▷ Anti-rotation system for incisal rod.
- ▷ Template with elliptic references for lower arches models.
- ▷ Occlusal table with elliptic references for upper arches models.

Questo è il nuovo articolatore non-Arcon a valor medio di Medesy, prodotto in alluminio pressofuso dal peso di 580gr circa. È stato progettato e realizzato in modo da lasciar ampia visibilità alle superfici linguali, preservando la stabilità in posizione aperta: il ritorno in asse è agevolato grazie a delle molle di richiamo. Le regolazioni di questo articolatore permettono di simulare esattamente il tragitto condiloideo per garantire precisione e occlusione ottimali, qualunque sia il movimento mandibolare del paziente.

Dettagli tecnici:

- ▷ Design per posizione di lavoro ergonomica a 60°.
- ▷ Compatibile per dimensione con i polimerizzatori a pressione in commercio.
- ▷ Sistema anti-rotazione per asta incisale.
- ▷ Calotta con traiettorie ellittiche di riferimento per modelli a partire da arcata inferiore.
- ▷ Piano oclusale con traiettorie ellittiche di riferimento per modelli a partire da arcata superiore.



NEWS

5222

Articulator with mounting plate
Articolatore con piastra



5222/1

Mounting plate
Piastra



5222/12

Complete magnet plate
Piastra magnetica completa

SET FOR MOBILE DENTAL PROSTHESIS SET PER PROTESI MOBILE

MEDESY
ITALY

600
YEARS



2105/Set

Content / Contenuto:

- 588 Wax and modeling instrument, Le Cron
- 593 Wax and modeling instrument, Zahle

592 Wax and modeling instrument, Zahle

202 Wax knife Fahnenstock

206 Wax knife Lessmann

201 Wax knife Fahnenstock

214 Wax knife Gritmann

221 Soldering tweezers, straight

1519 Ligature forceps, Halstead Mosquito

3511 Surgical scissors, Iris straight

3522 Crown and gold scissors, saw edge

3633 Scalpel handle N 3

4981 Caliper Iwanson

2810 Wire bending pliers, universal

Content can be changed upon request / Su richiesta il contenuto può essere cambiato

SET FOR FIXED DENTAL PROSTHESIS SET PER PROTESI FISSA

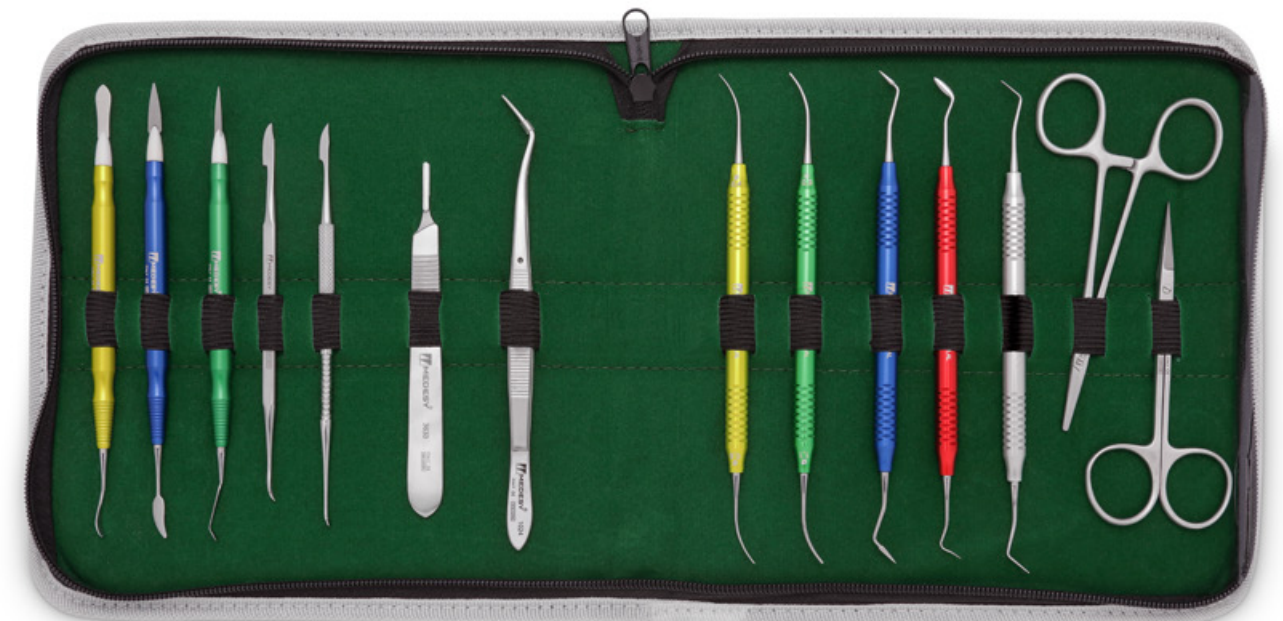

2100/Set

Content / Contenuto:

583/1.AL Modeling instrument, aluminium

583/2.AL Modeling instrument, aluminium

583/3.AL Modeling instrument, aluminium

583/4.AL Modeling instrument, aluminium

583/5.AL Modeling instrument, aluminium

3511 Surgical scissors, Iris straight

1519 Forceps Halstead Mosquito

1024 Cotton tweezers, Meriam

3633 Scalpel handle N. 3

596 Modeling instrument, Hylin

594 Modeling instrument, Hylin

575/1 Ceramic sculpting instrument

575/2 Ceramic sculpting instrument

575/3 Ceramic sculpting instrument

Content can be changed upon request / Su richiesta il contenuto può essere cambiato

IMPRESSION TRAYS, 6000 LINE
PORTAIMPRONTE, LINEA 6000

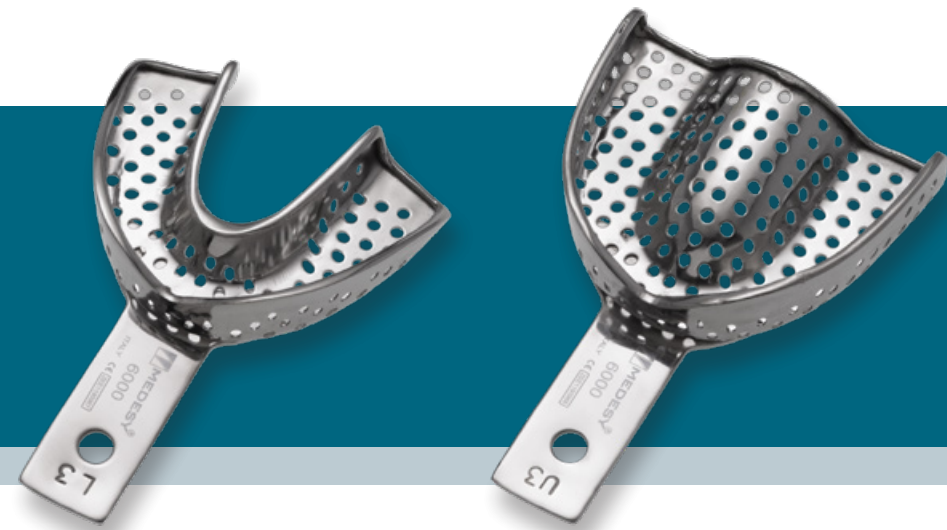

PERFORATED
FORATE



RETENTION RIM
BORDO RITENTIVO



IMPRESSION TRAYS, 6003 LINE
PORTAIMPRONTE, LINEA 6003

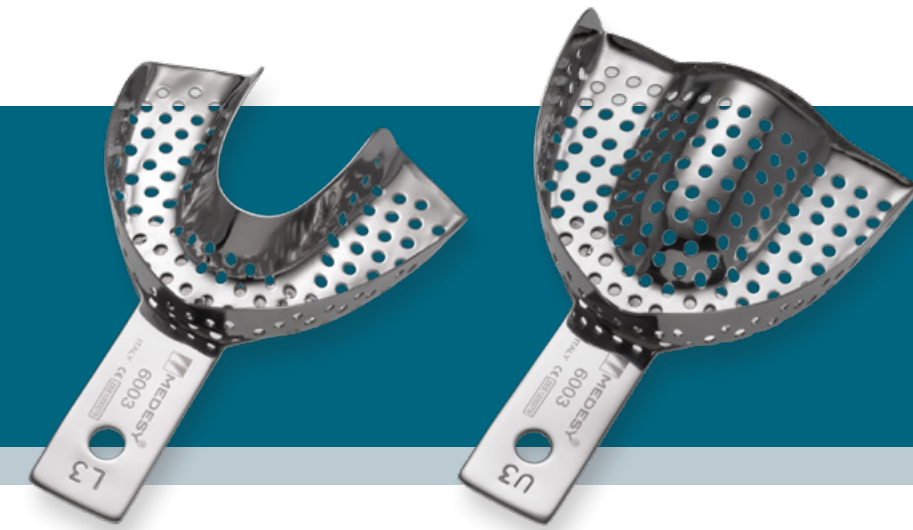

PERFORATED
FORATE



WITHOUT RETENTION RIM
SENZA BORDO RITENTIVO

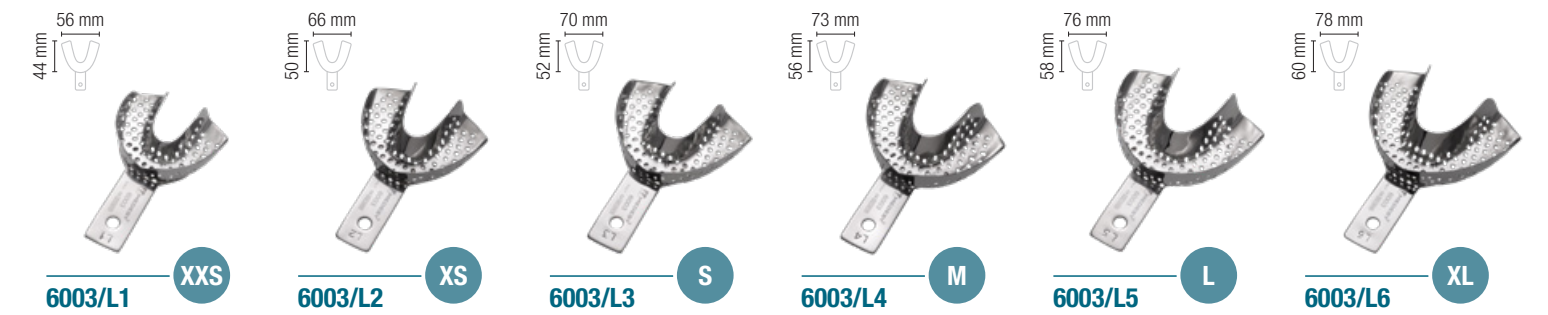
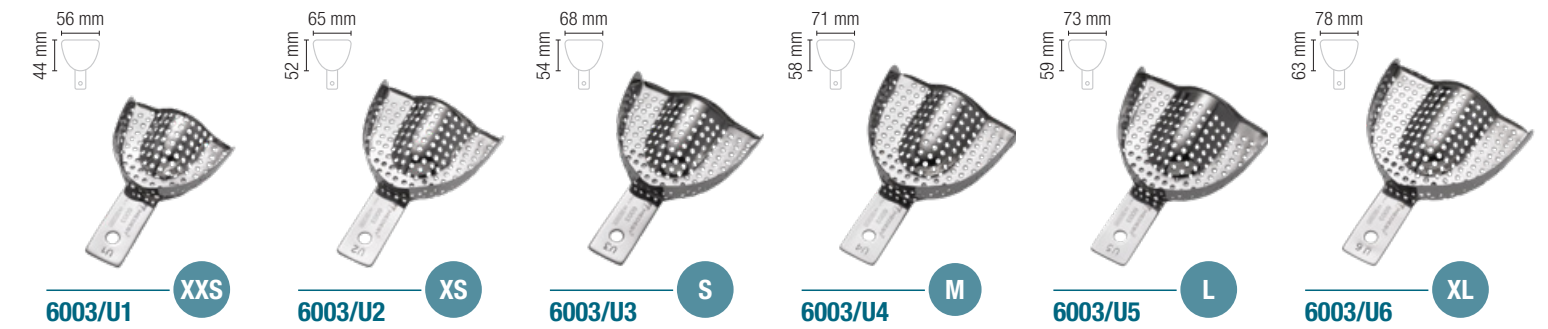
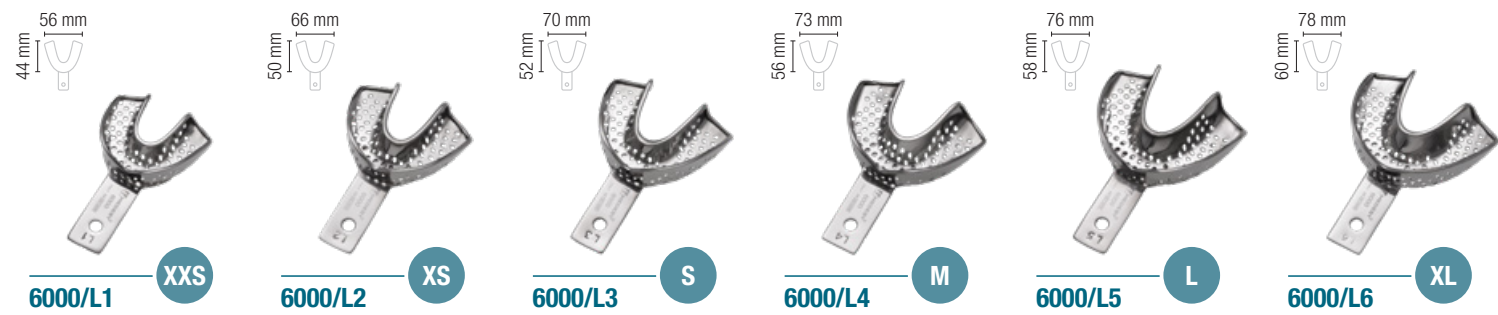
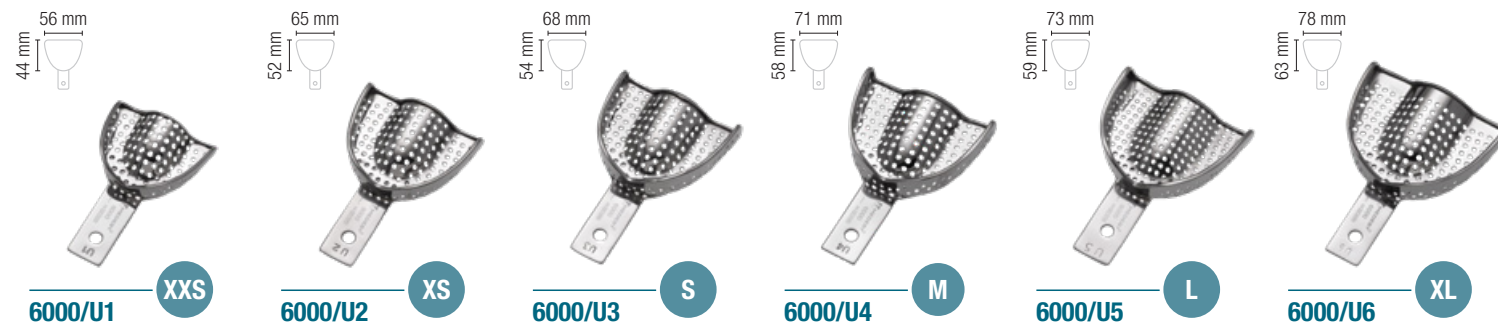

6000/KIT
Contains 12 pcs
Contiene 12 pz



6000/4 DR
Partial right
Parziale destro



6000/4 SL
Partial left
Parziale sinistro



6003/4 DR
Partial right
Parziale destro



6003/4 SL
Partial left
Parziale sinistro



6003/KIT
Contains 12 pcs
Contiene 12 pz

IMPRESSION TRAYS, 6005 LINE
PORTAIMPRONTE, LINEA 6005



NOT PERFORATED
NON FORATE

RETENTION RIM
BORDO RITENTIVO

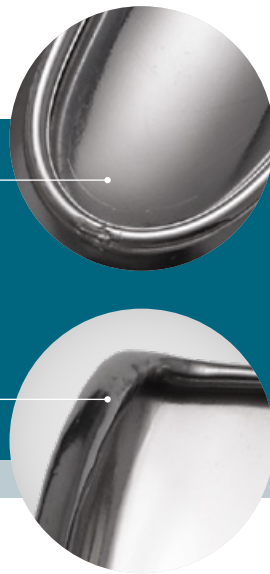

6005/KIT
Contains 12 pcs
Contiene 12 pz



6005/4 DR
Partial right
Parziale destro



6005/4 SL
Partial left
Parziale sinistro

IMPRESSION TRAYS, 6004 LINE
PORTAIMPRONTE, LINEA 6004

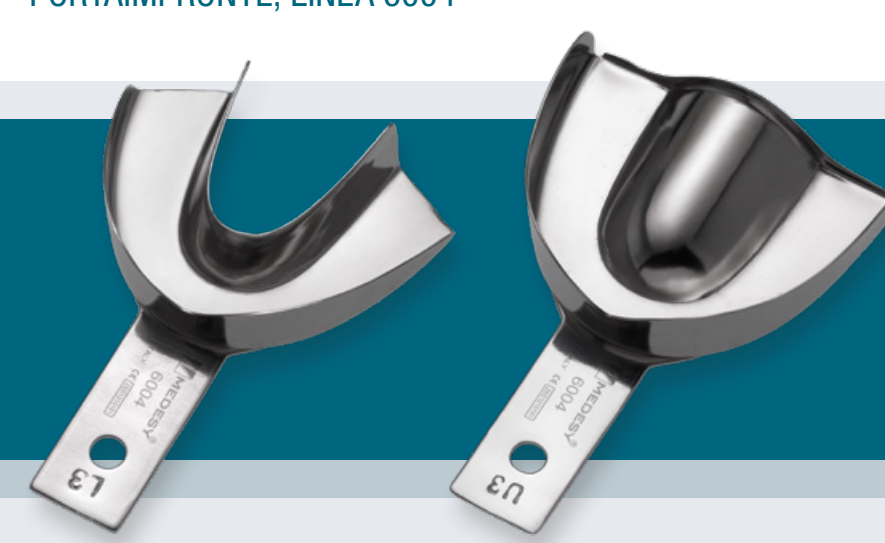

NOT PERFORATED
NON FORATE

WITHOUT RETENTION RIM
SENZA BORDO RITENTIVO

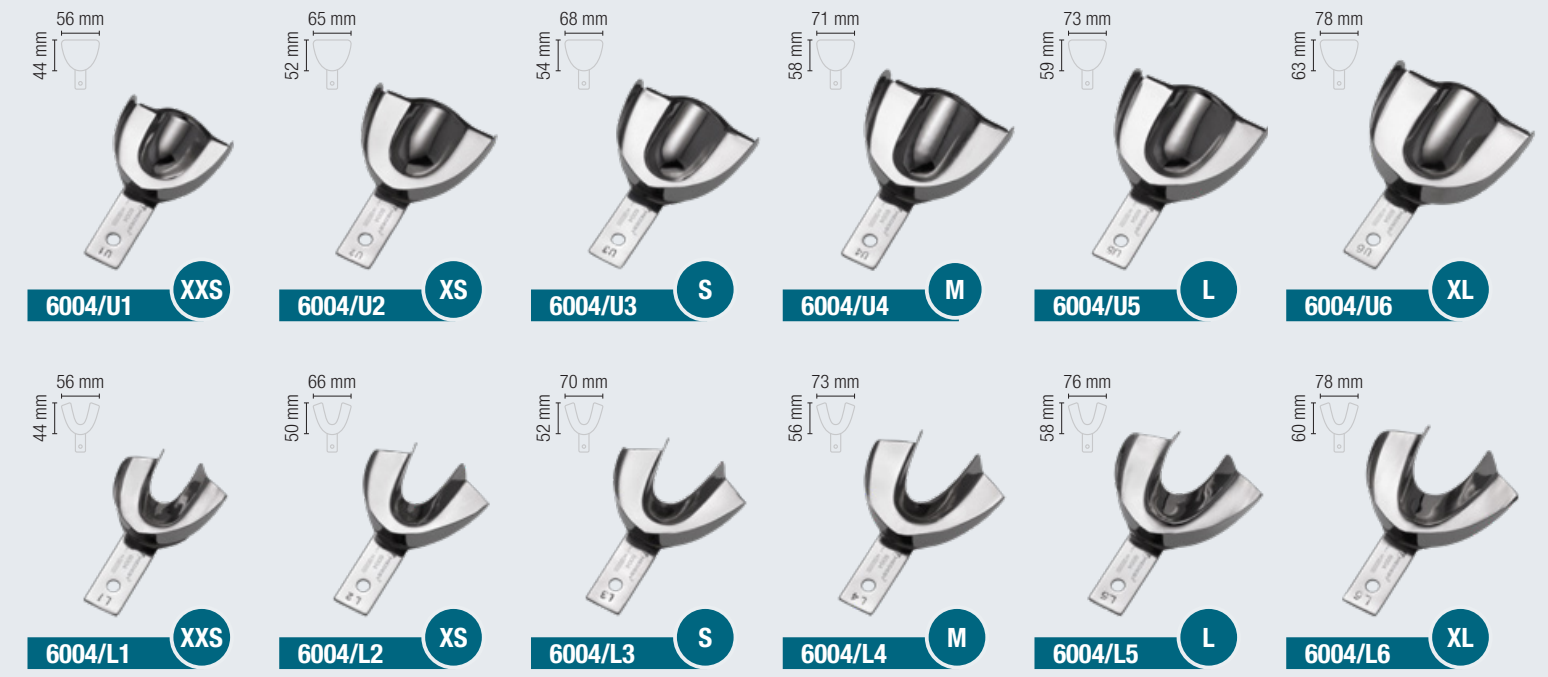
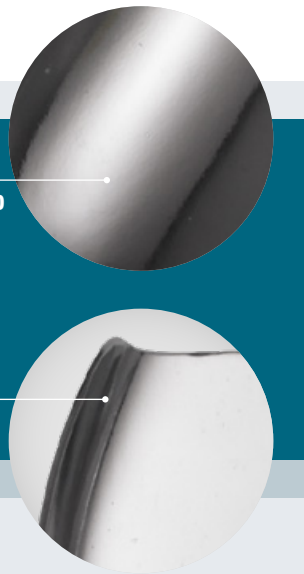

6004/KIT
Contains 12 pcs
Contiene 12 pz

NEWS



6004/4 DR
Partial right
Parziale destro



6004/4 SL
Partial left
Parziale sinistro

IMPRESSION TRAYS, EDENTULOUS

PORTAIMPRONTE, EDENTULI

IMPRESSION TRAYS, EDENTULOUS

PORTAIMPRONTE, EDENTULI

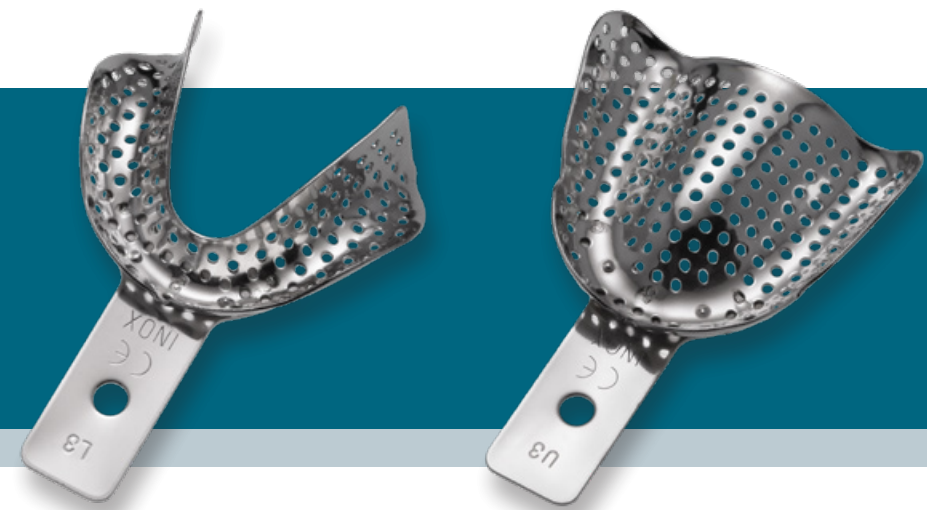

PERFORATED
FORATE



NOT PERFORATED
NON FORATE

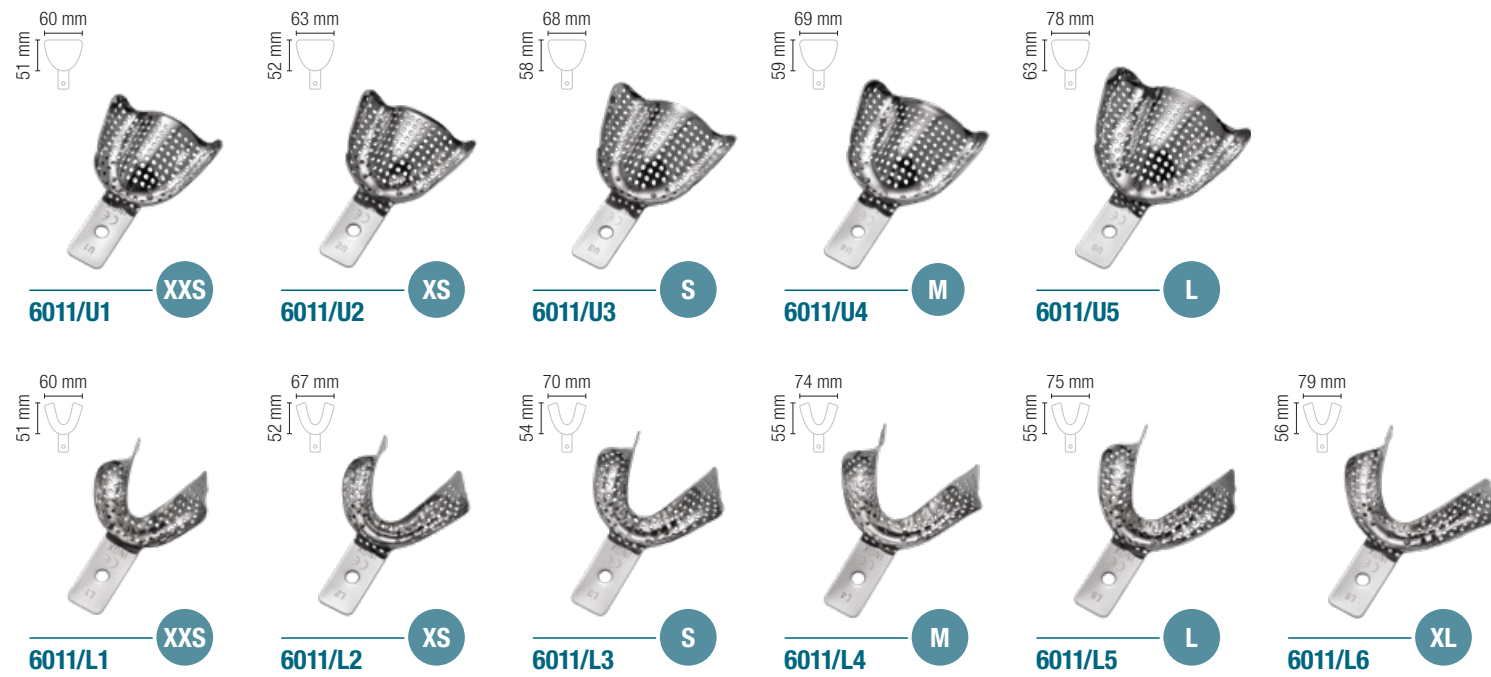

6011/KIT
Contains 11 pcs
Contiene 11 pz



6009/KIT
Contains 11 pcs
Contiene 11 pz



IMPRESSION TRAYS, ALUMINIUM
PORTAIMPRONTE, ALLUMINIO

IMPRESSION TRAYS, DISPOSABLE
PORTAIMPRONTE, MONOUSO

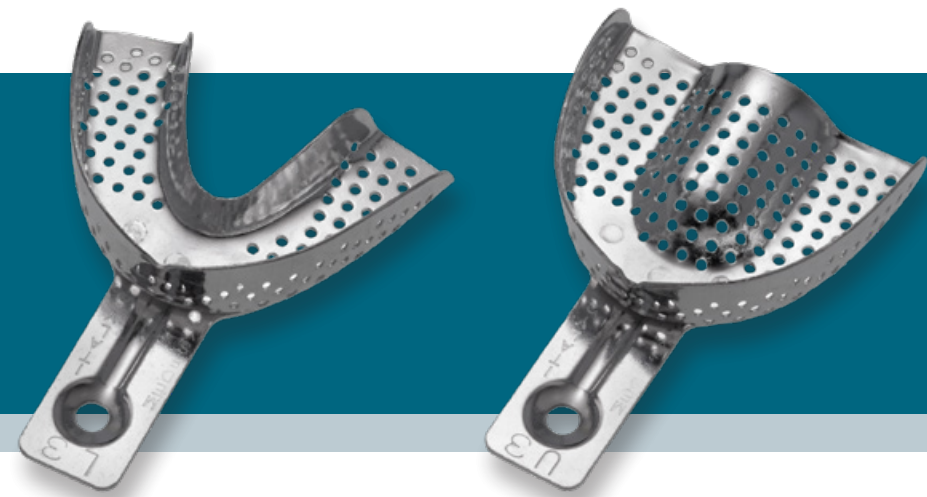

PERFORATED
FORATE

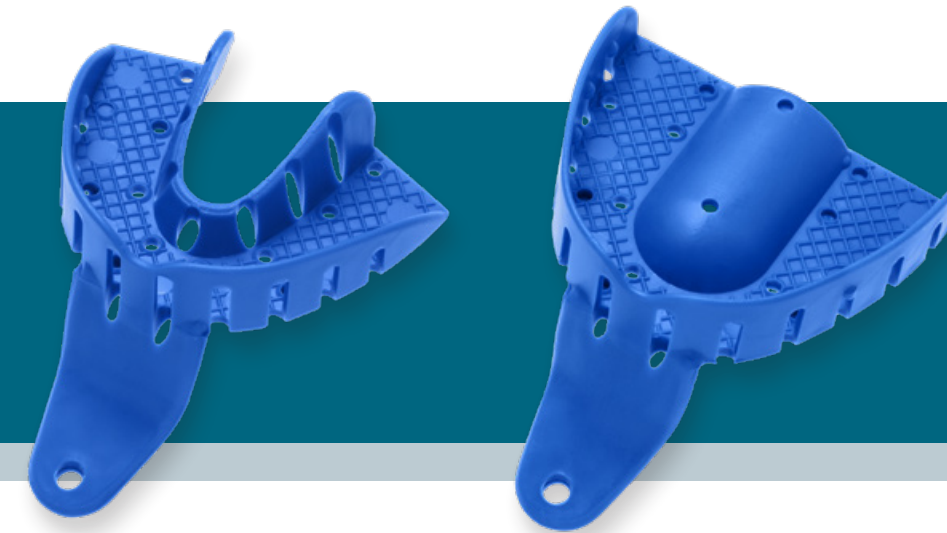
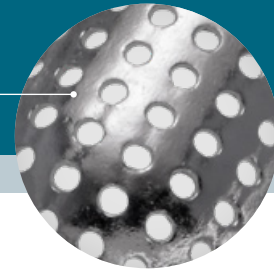

AUTOCLAVABILE AT 121° C
AUTOCLAVABILI A 121° C

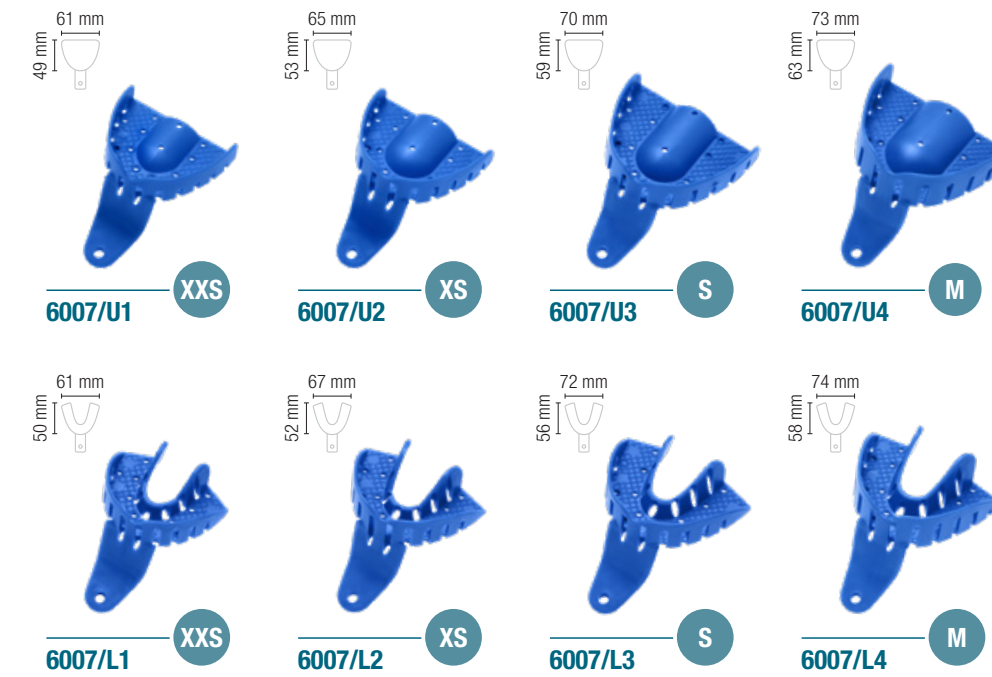
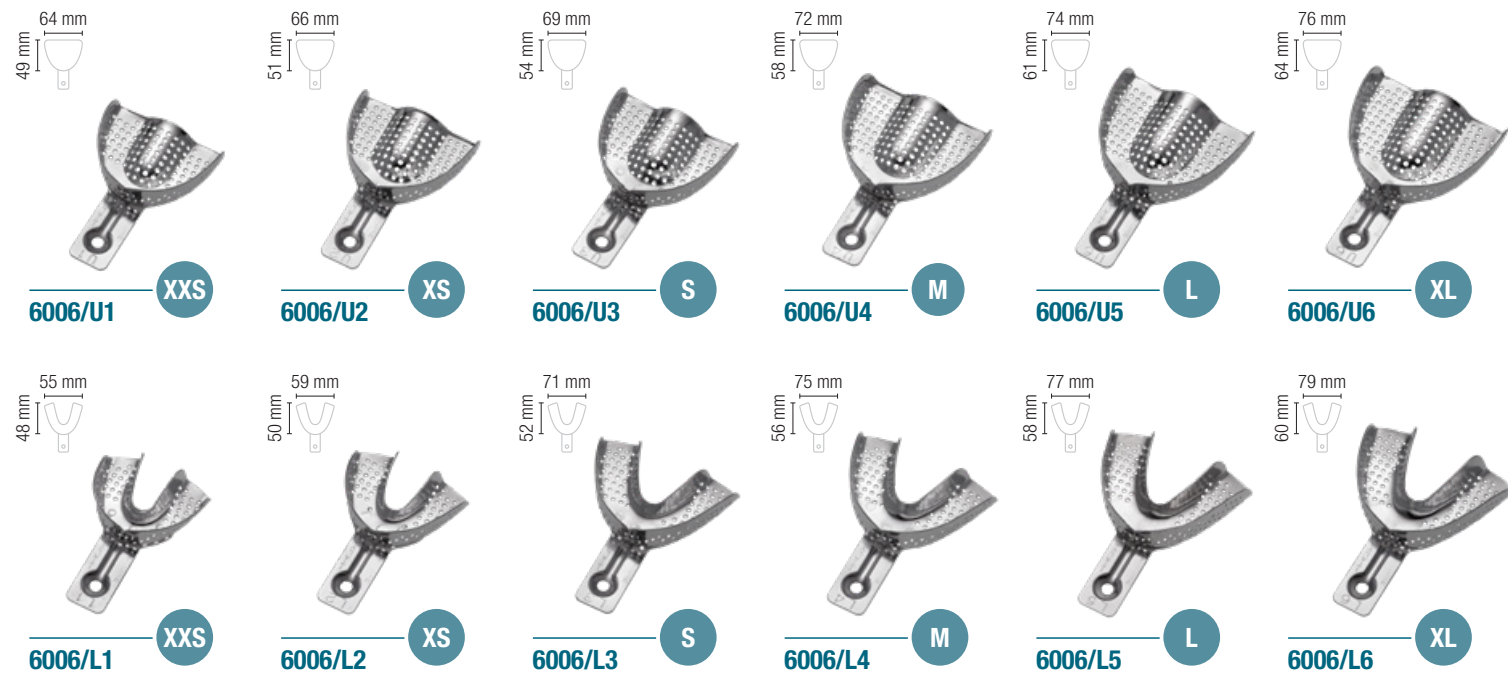

6007/16

Set of 16 pieces, 2 each without partials
Confezione da 16 pezzi, 2 per tipo senza parziali

NEWS

6007/24

Set of 24 assorted pieces
Confezione da 24 pezzi assortiti

6007/100

Set of 100 assorted pieces
Confezione da 100 pezzi assortiti



BENDABLE
PIEGHEVOLI



6006/4 DR
Partial right
Parziale destro

6006/4 SL
Partial left
Parziale sinistro



6007/4 DR1
Partial right 1
Parziale destro 1

6007/4 SL1
Partial left 1
Parziale sinistro 1

6007/4 DR2
Partial right 2
Parziale destro 2

6007/4 SL2
Partial left 2
Parziale sinistro 2



POLYCARBONATE IMPRESSION TRAYS PORTAIMPRONTE IN POLICARBONATO



121°C
🌡️

AUTOCLAVABILE AT 121° C
AUTOCLAVABILI A 121° C

For edentulous or partially toothed bites, autoclavable (more info upon request).
Per bocche edentule o parzialmente dentate, autoclavabile (su richiesta maggiori informazioni).

6008/24
Series of 24 polycarbonate impression trays and compasses for final impressions
Serie di 24 portaimpronte in polycarbonato più compasso per impronte definitive

SOLDERING TWEEZERS
PINZETTE PER SALDATURA



221
Straight
Retta
mm 165

222
Curved
Curva
mm 160

Fiber handles
Manico in fibra



4583
Miller
Articulating paper holder
Pinze carta articolazione



4955/S
Brusher
Scovolino



4955/A
Syringe for elastometers, aluminium
Siringa per elastomeri, alluminio



4955/P
Tips, spare part
Puntali di ricambio



574

Modeling knife
Cottello per modellare

Blade to remove exceeding material.
Lama per rimuovere il materiale in eccesso.



Mini-circular blade to trim off specific mesial and distal spots.
Lama mini-circolare per eliminare specifici punti mesiali e distali.

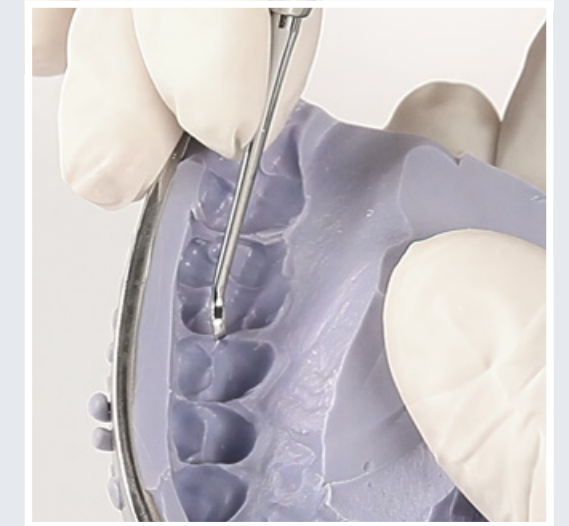

WATCH THE VIDEO ON
YouTube MEDESY CHANNEL!

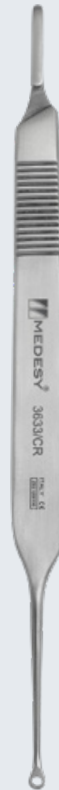

3633/CR

Modeling knife
Cottello per modellare

Fit all kind of blade #3 to remove exceeding material.
Montare tutti i tipi di lame #3 per rimuovere il materiale in eccesso.



Mini-circular blade to trim off specific mesial and distal spots.
Lama mini-circolare per eliminare specifici punti mesiali e distali.

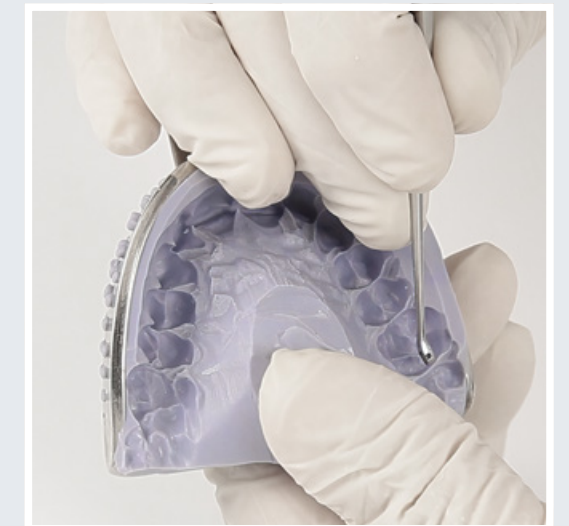

CALIPERS

CALIBRI



4983
Beerendonk
mm 130



4984
Züricher
mm 130



4982
Boley
mm 145



4988
Steel ruler
Righello in acciaio
mm 180



4980/C
Iwanson
For wax
Per cera
mm 100



4981/M
Iwanson
For metal
Per metallo
mm 100



2810
Universal
Wire bending pliers
Pinze piega fili
mm 155